	<p>CNES</p> <p>DEBRISK</p>		Ref.	DBK-MU-LOG-0268-THA	
			Date	13/11/2025	
			Version	2.23	Page: 1/120

# DEBRISK software user's manual LOS mode



	NAME and ACRONYM	DATE and SIGNATURE
Written by	THALES/RTECH DEV Team	13/11/2025
Verified by	Aurélie BELLUCCI CNES/DTN/MSO/DVS	13/11/2025
Approved by	Project Manager Grégoire LAUR DOA/SME/LOS	13/11/2025

	CNES		Ref.	DBK-MU-LOG-0268-THA		
	DEBRISK		Date	13/11/2025		
			Version	2.23	Page: 2/120	

# DEBRISK software user's manual



## LOS mode

	NAME and ACRONYM	DATE and SIGNATURE
Written during the maintenance by	THALES/RTECH DEV Team	13/11/2025
Verified by	Cyril PROCH (THALES SERVICES NUMERIQUES)	13/11/2025
Approved by	Project Manager Nicola NATALE (THALES SERVICES NUMERIQUES)	13/11/2025

	CNES  DEBRISK		Ref.	DBK-MU-LOG-0268-THA	
			Date	13/11/2025	
			Version	2.23	Page: 3/120

## Distribution list

NAME	ACRONYM
BELLUCCI Aurélie	DTN/MSO/DVS
MONTAGNON Etienne	DSO/MSO/DVS
ANNALORO Julien	DTN/TVO/PR
GALERA Stéphane	DTN/TVO/PR
CHARRON Yann	DTN/TVO/PR
LAUR Grégoire	DOA/SME/LOS
ElJed Olfa	DOA/SME/LOS
ALCARIA Cloe	DTN/MSO/MDV
CARRETIE Laura	DTN/QE/NEO
ZEMOURA Melissa	DTN/STS/SPC
FARAGO François	DTN/STS/SPC
MARTINEZ TORIO Alexandra	DTS/LOS


	<p>CNES</p> <p>DEBRISK</p>		Ref.	DBK-MU-LOG-0268-THA	
			Date	13/11/2025	
			Version	2.23	Page: 4/120

## SUMMARY OF CHANGES

Issue	Revision	Date	Purpose of the modification
			Original reference: PR-DEBR-MU-110930-0463-RTECH Initial version written by Fabien GUICHARD (RTECH).
1	0	03/11/2011	First revision
1	1	08/11/2011	Update following remarks from CNES
1	2	09/11/2011	Material properties added and conductivity deleted
1	3	14/12/2011	Review item discrepancies taken into account
1	4	15/12/2011	“Import from DAS” section added
2	0	20/07/2012	DEBRISK V2.0
2	1	25/07/2012	Modification following DEBRISK.103 action
2	2	16/08/2012	Further information on SIRIUS ephemeris data files and extra expert settings added
2	3	22/08/2012	FA 493, 495 and v7 proofreading sheet taken into account
2	4	10/09/2012	Modifications for Debrisk v2.05.00
2	5	05/12/2012	CNES remarks made during the meeting on documentation taken into account
2	6	11/07/2013	FA 534 and DM 611 and 617 taken into account

	CNES  DEBRISK		Ref.	DBK-MU-LOG-0268-THA	
			Date	13/11/2025	
			Version	2.23	Page: 5/120



			New reference: DBK-MU-LOG-0258-CNES
1	0	13/01/2014	DM 685 Default parameter values and document management by CNES taken into account
2	0	28/02/2014	Due to the change of contract, this version of the document follows reference document DBK-MU-LOG-0258-CNES version 01.00". DM 686: nomenclature changed from “expert mode” to “scientific mode”.
2	1	25/04/2014	CNES remarks taken into account (CNES_relecture_MUscientifique_GMV_24032014): MM-3: §7.6.2.3, clarification regarding the box. MM-4: §7.5.1.1, clarification regarding the DAS file. DM-713: §7.6.1.1, §7.4.1 use of the “—userMaterials” option
2	2	18/11/2014	FA-727: Use of a UTF-8 compatible editor Additional information on the way to custom the JVM memory. Section 7.10 (FEP-3 FEPS_DEBRISK_pk_man_fa_dd_mm_01_02.xls) Additional terms added in section 3 (project action) DM-752: Modification in the ergonomics of DEBRISK GUI
2	3	09/12/2014	Corrections due to FEPS raised by CNES during PKPV
2	4	24/02/2015	Added a warning to indicate that all the exported files (Electra, Google Eart, CSV) are done using the UTF-8 encoding.  Clarification of the use of the quantity attribute of a fragment for the computation of the thermal_mass and the casualty_area.
2	5	13/04/2015	Corrections taking into account CNES remarks raised after V02.07.01 delivery (DBK-MU-LOG-0258-GMV_02_04-RemPO)  FA-810: § 7.5.1.5, § 8.2.1.3, clarifications on the logic followed for defining the colours of “demise altitude” and “impact energy”.

	<p>CNES</p> <p>DEBRISK</p>		Ref.	DBK-MU-LOG-0268-THA	
			Date	13/11/2025	
			Version	2.23	Page: 6/120


2	6	07/05/2015	FA-830: § 6.3, § 7.1, correction of minimum Java Virtual Machine version.
2	7	12/12/2015	<p>DM-827 : Prise en compte de la STB du logiciel DEBRISK ed3 rév9 et autres évolutions du logiciel DEBRISK</p> <p>Section 7.2 screenshot update to take into account the updates in the GUI.</p> <p>Section 7.4.1: Addition of the -f flag to generate DML files in batch mode.</p> <p>Section 7.5.1: Added the operation of the new “Import TLE” button (DEBRISK_675).</p> <p>Section 7.5.1, section 8.2.1.3 : Added the new “Global Casualty Area” widget.</p> <p>Section 7.5.1: Added the information about the display of automatically modified objects (DEBRISK_545 and DEBRISK_546).</p>
2	8	15/04/2016	<p>DM-833: Modification of section 7.6.2 to explain the computation of dimensions.</p> <p>FA-872: Modification of section 8.2 to describe the modifications in the csv header.</p> <p>DM-846 : Modification of section 5 to remove some resources that are not needed anymore.</p> <p>Creation of section 7.5.1.5 Result Panel to detail the contents of the result panel after the execution.</p>

	CNES  DEBRISK		Ref.	DBK-MU-LOG-0268-THA	
			Date	13/11/2025	
			Version	2.23	Page: 7/120



2	9	27/04/2017	<p>DM-891: Modification of section 7.4.1 to include the new expert parameters to define the satellite ablation, ballast parameters and objet file creation.</p> <p>Modification of section 7.5.1.3 to include the satellite mass decomposition in the information area.</p> <p>Modification of section 7.5.1.3 to include the aerodynamic mass field in the satellite definition dialog and its definition.</p> <p>Modification of section 7.5.1.3 to include the new functionality of accepting the dimensions of an object even if they are incoherent.</p> <p>DM-933: Modification of section 7.5.1.3 to describe the new algorithm of dimension input and to indicate the possible differences in two similar objects defined using different methods.</p> <p>Modification of section 7.5.1.3 and 7.6.2 to indicate the rounding of dimensions with too many significant digits.</p> <p>Modification of section 7.6.2.5 to include the new table with the significant digits per dimension.</p>
2	10	07/07/2017	<p>Implementation of CNES document corrections after review of version 2.9.</p> <p>FA-991 update of error messages related to the definition of the fragments. Section 9.4.2</p>
2	11	08/12/2017	<p>Modified the section 7.5.1.3 to include the information about the ballast mass and the aerodynamic mass of the satellite.</p> <p>Added section 7.5.1.4 to describe the new simulation parameters tab.</p> <p>Updated images to show the new simulation parameters section.</p>
2	12	05/12/2018	<p>Modification of section 7.5.1.3: addition of statement that the initial aerodynamic mass contains the mass of the solar panels. Change of screenshot to display the updated ones (with according correction of label for total mass with solar panels). Update of the screenshot of the right numerical values displayed in the edition of the spacecraft.</p> <p>Name of the frame displayed in IHM: modification of section 7.5.1.2, modification of the overall screenshots.</p> <p>Modification of section 8.2: addition of quantity, initial Ccond, final Ccond parameters in CSV file. Update list of parameters in TecPlot.</p>

	CNES  DEBRISK		Ref.	DBK-MU-LOG-0268-THA	
			Date	13/11/2025	
			Version	2.23	Page: 8/120


2	13	15/02/2019	<p>Modification of section 5 to include the complex shapes and the interpolator files (DM-1046).</p> <p>Modification of section 6.2 to include the new versions of Windows.</p> <p>Modification of section 7.5.1.3 to include de new complex shapes geometric parameters (DM-1048).</p> <p>Modification of section 7.5.1.4 to include the information about the parameter's visibility depending of the other parameters value, and update of the parameters panels to include the new parameters (DM-1046).</p> <p>Added section 7.6.2.5 and 7.6.2.6 to include the definition of the complex shapes and their constraints (DM-1046).</p> <p>Modification of section 7.15 to include the errors related to the complex shapes (DM-1046).</p> <p>Modification of section 8.2 to include the information about the modifications of the output files (DM-1046, DM-1056, DM-1069).</p>
2	14	29/11/2019	<p>DM-1082: Modified section 7.5.1.7 to update the graphic plots.</p> <p>DM-1085: Modified the section 9.2 to modify the parameter ReferenceArea in ReferenceAeroAera and to add the new parameters ReferenceThermalArea and Qcond.</p> <p>DM-1098: Modified the sections 6.3 and 7.1 to indicate that Java 1.8 is the minimum version to use for the virtual machine.</p>
2	15	20/01/2021	<p>DM 1101 : Added section 7.7 "Heat flow" to explain that the absorbed radiation flux is null.</p> <p>Section 7.7 transformed into "Survivability parameter". The section "Normal shutdown" becomes section 7.8</p> <p>DM-1427: Figures 19 (Adding a root object window), 49 (Box tumbling) and 50 (Flat plate tumbling) updated so only the accurate rotation arrows are displayed.</p> <p>DM-1446 : Modified section 7.5.1.5 to add the fact that :</p> <ul style="list-style-type: none"> <li>- there is one Materials tab per simulation (so the Materials tab are independent),</li> <li>- there are some materials defined by default in the material tab, that are displayed in purple, named "xx DEBRISK", and that cannot be modified,</li> <li>- there are two buttons in this tab ("save materials" and "load materials").</li> </ul> <p>Screenshot fig36 changed to show the list of purple materials.</p> <p>Modified section 7.6.1.2 to add the default materials are displayed in purple, named "xx DEBRISK" and cannot be modified.</p>

	CNES  DEBRISK		Ref.	DBK-MU-LOG-0268-THA	
			Date	13/11/2025	
			Version	2.23	Page: 9/120

			<p>Modified section 7.6.1.3 to add the fact that the existing "materials ""xx DEBRISK" can be duplicated, but the copy cannot be registered as ""xx DEBRISK", and the oxidation properties are not be duplicated.</p> <p>DM-1462 : section 7.5.1.3 modified to add spheres as possible satellite shapes.</p> <p>DM-1463 : section 9.2 modified to add the fact that the name, creation date, version and mode are written at the beginning of the csv and Tecplot files.</p> <p>DM-1465 : section 7.4.1 modified to delete the ELECTRA file from the list of files that can be Generated.          section 7.5.1.1 modified to remove any mention of the ELEcTRA file.          section 8.5.4 modified to remove the ElectraFileException          section 9.1 modified to remove the reference to the creation of an ELEcTRA file.          section 9.2 modified to remove any reference to the ELEcTRA file.          section 9.3.1 modified to remove any reference to the ELECTRA file. This section no longer is centered on the creation of an ELECTRA file, but on the creation of a simulation, and on the exportation of the result files.</p> <p>DM-1460 : section 7.6.2.5.2 modified to change the condition on h.</p> <p>Added section 7.8 to include the oxidation flow equations.</p>
2	16	26/11/2021	<p>DM-1474: Updated object images in section 7.7 "Shape of objects".</p> <p>DM-1485: Addition of section 7.7.1.5 to describe the new hemispherical cylinder.</p> <p>DM-1559: Removed section 7.7.1.7 containing the significant digits for object dimensions.</p>
2	17	11/02/2022	<p>Modified section 7.6.1.1 to remove the paragraph about the default location of the userMaterials file that is not applicable to the LOS mode.</p> <p>Modified section 7.5.1.1 to update the description of the cross section area result and the associated screenshot.</p> <p>Modified section 7.5.1.6 to improve the description of the save action.</p> <p>Added section 9.5 with the 3D view configuration description.</p>

	CNES  DEBRISK		Ref.	DBK-MU-LOG-0268-THA	
			Date	13/11/2025	
			Version	2.23	Page: 10/120

2	18	02/11/2022	<p>DM-1626: Added section 7.5.1.5.1 to explain the loading of a material list in the IHM.</p> <p>DM-1627: Modified section 7.5.1.1 do add the new "Save As..." menu.</p> <p>DM-1646: Modified section 10.2 to add the new "azimuth" column to the Tecplot file definition.</p> <p>DM-1659: Modified section 10.2 to remove the "spacecraftMass" column from the Tecplot file definition.</p>
2	19	22/05/2023	<p>DM-1652:          Modification of the fragmentation validity range.          Update of screenshots to reflect the change of the IHM look &amp; feel.          Modification of section 7.5.1.1 to include the Help menu description.          Modification of section 7.5.1.2 to remove the fragmentation altitude.          Modification of section 7.5.1.4 to include the update of simulation parameters section.</p> <p>DM-1670:          Modification of sections 7.5.1.2, 7.5.1.3 and 7.6.1.3 to include the information about the warning message for incoherences in the input values.</p> <p>DM-1689:          Modification of section 7.4.1 to include the generation of the Cb/Mach file.</p> <p>DM-1692:          Modification of section 7.5.1.6 to include the definition of the weighted casualty area.</p> <p>DM-1693:          Addition of section 7.5.1.8 to describe the message area.</p> <p>DM-1695:          Modification of section 9.5.3 to indicate how to deactivate the 3D view manually.</p> <p>Global update of screenshots.</p>

	CNES  DEBRISK		Ref.	DBK-MU-LOG-0268-THA	
			Date	13/11/2025	
			Version	2.23	Page: 11/120

2	20	06/11/2023	<p>FA-1723 correction implemented in section §7.7.1.6.</p> <p>DM-1725 Home page figure updated in §7.5.1.</p> <p>FA-1722 Correction dimensions maximales tube §9.4.2.</p> <p>DM-1733 Added the information about the licence in §7.5.1.1</p> <p>DM-1724 Update of section §7.6.1.3 to take into account that the emissivity shall be in the range [0,1].</p>
2	21	06/12/2024	<p>LOS_FT-28: Updated images and description in section 7.5.1.2 "Scenario area".</p> <p>LOS_FT_22: Removal of constant drag coefficient, and addition of constant ballistics coefficient</p>
2	22	21/03/2025	Minor corrections/updates in the document
2	23	13/11/2025	<p>LOS_FT-45 : Handbook ( English version ) available in Help menu</p> <p>LOS_FT-86: upgrade from Java 8 to Java 21</p>

	<p>CNES</p> <p>DEBRISK</p>		Ref.	DBK-MU-LOG-0268-THA	
			Date	13/11/2025	
			Version	2.23	Page: 12/120

## Contents

1	Introduction.....	18
2	Applicable and reference documents .....	19
2.1	Applicable documents.....	19
2.2	Reference documents .....	19
3	Terms, definitions and abbreviations.....	20
4	Conventions.....	21
4.1	Symbols .....	21
4.2	Stylistic conventions.....	21
4.3	Initial conditions of simulation models.....	21
4.4	Purpose of the software.....	22
5	External view of the software .....	24
6	Operational environment.....	25
6.1	General.....	25
6.2	Hardware configuration .....	25
6.3	Software configuration .....	25
7	Operating Manual .....	27
7.1	Configuration and initialisation.....	27
7.2	Installation of DEBRISK.....	27
7.3	Uninstallation.....	30
7.4	Mode selection and control .....	31
7.4.1	The console mode .....	31
7.4.2	The IHM mode.....	33
7.4.3	Log management.....	33
7.5	Normal operation.....	34
7.5.1	Graphic interface .....	34
7.5.1.1	Menu.....	35
7.5.1.2	Scenario area .....	38
7.5.1.3	Objects tab.....	43
7.5.1.4	Simulation Parameters tab .....	58
7.5.1.5	Materials tab.....	59
7.5.1.6	Result Panel .....	61
7.5.1.7	Viewing area .....	64
7.5.1.8	Message zone .....	68
7.6	Materials .....	69
7.6.1.1	Materials file .....	69
7.6.1.2	Integrated materials .....	69
7.6.1.3	Materials created by the user.....	69
7.7	Shape of objects.....	72
7.7.1.1	Sphere.....	73
7.7.1.2	Cylinder .....	75
7.7.1.3	Box .....	77

	<p>CNES</p> <p>DEBRISK</p>		Ref.	DBK-MU-LOG-0268-THA	
			Date	13/11/2025	
			Version	2.23	Page: 13/120

7.7.1.4	Flat plate .....	78
7.7.1.5	Hemispherical cylinder .....	79
7.7.1.6	Complex shape.....	80
7.8	Heat flow .....	85
7.9	Oxidation flows .....	85
7.10	Survivability parameter.....	86
7.11	Global results .....	86
7.11.1	Total casualty area.....	86
7.11.2	Total impact mass.....	86
7.11.3	Total number of processed objects.....	87
7.11.4	Total impacting number of fragments .....	87
7.11.5	Total survivability .....	87
7.11.6	Total wall time .....	88
7.11.7	Total CPU time.....	88
7.11.8	Fragmentation altitude.....	88
7.12	Normal shutdown .....	88
8	Error situation .....	89
8.1	Recovery procedures.....	89
8.2	Java Virtual Machine (JVM) memory management.....	89
9	Reference manual .....	92
9.1	Introduction .....	92
9.2	Definitions and operation of the monitor.....	92
9.3	Plate ablation .....	92
9.4	Error messages.....	93
9.4.1	Error messages when entering the initial conditions.....	93
9.4.2	Error messages when creating an object .....	93
9.4.3	Error messages when creating a new material .....	100
9.4.4	Error messages when reading an input file .....	101
9.4.5	Operation error messages.....	102
9.5	3D View configuration.....	104
9.6	.....	105
10	Tutorial .....	106
10.1	Introduction .....	106
10.2	Starting up.....	106
10.2.1	Scenario area.....	111
10.2.1.1	Object tab .....	111
10.2.1.2	Materials tab.....	113
10.2.1.3	Viewing area .....	113
10.3	Using the software for a typical task.....	115
10.3.1	Creation of a simulation and result files.....	115

	<p>CNES</p> <p>DEBRISK</p>		Ref.	DBK-MU-LOG-0268-THA	
			Date	13/11/2025	
			Version	2.23	Page: 14/120

## TABLE OF FIGURES

Figure 1 Opening the wizard. ....	28
Figure 2 Selecting the installation directory. ....	28
Figure 3 Installation in progress ....	29
Figure 4 Selecting a shortcut if required.....	29
Figure 5 End of the installation ....	30
Figure 6 Uninstallation window ....	31
Figure 7 Uninstallation completed.....	31
Figure 8 Home page.....	34
Figure 9 Menu.....	35
Figure 10: About dialog.....	37
Figure 11: Licence dialog. ....	37
Figure 12 Scenario area ....	38
Figure 13 orbit containing the incoherences.....	42
Figure 14 Object tab ....	44
Figure 15: Total casualty area after a simulation reset. ....	45
Figure 16: Negative ballast mass.....	45
Figure 17: Total casualty area value after an execution. ....	45
Figure 18 Adding a root object window. ....	46
Figure 19 Adding an object window. ....	46
Figure 20 : Linear model for conductance.....	48
Figure 21 : Polynomial model for conductance.....	49

	<p>CNES</p> <p>DEBRISK</p>		Ref.	DBK-MU-LOG-0268-THA	
			Date	13/11/2025	
			Version	2.23	Page: 15/120

Figure 22 Adding solar panels .....	50
Figure 23 Incoherence dimensions dialog .....	50
Figure 24: confirmation dialog .....	51
Figure 25 Display of an incoherent object.....	51
Figure 26: Relationship menu.....	52
Figure 27 Display of read only dimensions .....	54
Figure 28 Information table .....	54
Figure 29 Object edit interface. ....	55
Figure 30 Editing an object directly in the table.....	56
Figure 31 Wrong value while editing an object directly in the table.....	56
Figure 32: Dialog to inform the user about the automatic modification of the object properties. ....	57
Figure 33: Automatically modified object in input panel.....	57
Figure 34: Automatically modified object in result panel. ....	57
Figure 35: Simulations Parameters tab .....	58
Figure 36 Unknown materials warning pop-up .....	59
Figure 37 Materials tab Panel .....	60
Figure 38 Materials tab thermal properties graph.....	60
Figure 39 Load materials confirmation dialog .....	61
Figure 40: Selection of missing material properties .....	61
Figure 41 Results table .....	62
Figure 42 Viewing area on the right .....	64
Figure 43 Creation of custom plot .....	65
Figure 44 Invert plot .....	65

	CNES  DEBRISK		Ref.	DBK-MU-LOG-0268-THA	
			Date	13/11/2025	
			Version	2.23	Page: 16/120

Figure 45 Simulation viewed in Google Earth .....	67
Figure 46: Message area .....	68
Figure 47 Adding a customised material. ....	70
Figure 48: Confirmation dialog for invalid materials.....	70
Figure 49 Entry of a linear evaluation .....	71
Figure 50 Entry of a polynomial.....	71
Figure 51 Spheres defined using different methods, obtaining different results.....	73
Figure 52 Hollow sphere random tumbling.....	73
Figure 53 Solid sphere random tumbling. ....	74
Figure 54 Hollow cylinder random tumbling .....	75
Figure 55 Solid cylinder random tumbling.....	76
Figure 56 Box tumbling.....	77
Figure 57 Flat plate tumbling. ....	78
Figure 58 Hollow hemispherical cylinder random tumbling.....	79
Figure 59 Complex conical shape tumbling. ....	81
Figure 60 Complex conical shape profile.....	81
Figure 61 Complex spherical shape tumbling. ....	83
Figure 62 Complex spherical shape profile.....	84
Figure 63 Closing the software.....	88
Figure 64 Simulation not saved warning pop-up.....	89
Figure 65 Memory monitor .....	91
Figure 66 Error message .....	94
Figure 67 Entry of a user-defined material.....	100


	<p>CNES</p> <p>DEBRISK</p>		Ref.	DBK-MU-LOG-0268-THA	
			Date	13/11/2025	
			Version	2.23	Page: 17/120

Figure 68 Menu.....106

Figure 69 Entry conditions .....110

Figure 70 Creating an object.....111

Figure 71 Swap objects table view .....114

Figure 72: Total casualty area value after an execution. ....115

Figure 73 Menu.....115

Figure 74 Entry conditions .....116


Figure 75 Creating a spacecraft. ....117

Figure 76 Creating a child object.....118

Figure 77 Results and viewing area.....119

Figure 78 Export file pop-up .....119


Figure 79 Importing a file encoded following the UTF-8 format in Excel .....120

	<p>CNES</p> <p>DEBRISK</p>		Ref.	DBK-MU-LOG-0268-THA	
			Date	13/11/2025	
			Version	2.23	Page: 18/120

# 1 Introduction

This document is a manual whose purpose is to give an exhaustive introduction to the functions available to the DEBRISK user performing simulations of the ablation of debris from a spacecraft after it has been destroyed upon re-entry into the atmosphere.

DEBRISK has been created by RTECH under a development contract for CNES. It is now in the maintenance phase by GMV, under contract for CNES.

	CNES  DEBRISK		Ref.	DBK-MU-LOG-0268-THA	
			Date	13/11/2025	
			Version	2.23	Page: 19/120

## 2 Applicable and reference documents

### 2.1 *Applicable documents*

ID	Document	Reference	Issue	Date
AD1	Technical Requirement Specifications	DBK-CT-SPEC-009-CNES	5.6	9/10/2024

### 2.2 *Reference documents*

ID	Document	Reference	Issue	Date

	CNES  DEBRISK		Ref.	DBK-MU-LOG-0268-THA	
			Date	13/11/2025	
			Version	2.23	Page: 20/120

### 3 Terms, definitions and abbreviations

Terms	Definition
Spacecraft	A spacecraft is the parent object of all other user-defined objects. It comprises a (cylindrical, spherical or parallelepiped) main body, and one or more solar panels if it is needed. When re-entering the atmosphere at the end of its life, the spacecraft first loses its solar panels, and then splits into one or more fragments at a given altitude.
Child	A child is a fragment within another object. By definition, a fragment is a child, either of another fragment, or of the spacecraft. An object may have several children. Children are released into the atmosphere where the parent ceases to exist.
Thermal mass	The thermal mass is the mass of an object, not including the mass of its children, if any.
Object	An object may be a spacecraft or a fragment.
Fragment	A fragment is a part of the spacecraft, as defined by its shape, its dimensions and its material. A fragment only exists after fragmentation of the spacecraft.
Aerodynamic mass	The aerodynamic mass is the mass of an object, including the mass of all generations of children, if any.
Downrange (IHM, .dat file)	Length of the projection of object's trajectory on the Earth's surface (from the re-entry point of the space craft)
Local downrange (dat file)	Downrange computed from the moment the child is born.
Downrange shortest	Minimum distance between the initial point of the SC trajectory's projection on the Earth's surface and the impact point.

	CNES  DEBRISK		Ref.	DBK-MU-LOG-0268-THA	
			Date	13/11/2025	
			Version	2.23	Page: 21/120

## 4 Conventions

### 4.1 Symbols



A red triangle indicates an important remark.

### 4.2 Stylistic conventions

Stylistic conventions are used to highlight elements in the DEBRISK program.

- *Button* « Button » “Button” references to software buttons are between quotation marks, French quotation marks or in italics.
- Important words are underlined.
- `Command lines` are written using the Courier font.

### 4.3 Initial conditions of simulation models

- An object is considered destroyed when its kinetic energy is below 14 J.
- The object temperature at birth, i.e. the initial simulation temperature, is 300 K for all objects.
- The atmosphere model used is the US 76 model.
- A central force model is used as the gravity model.

	CNES  DEBRISK		Ref.	DBK-MU-LOG-0268-THA	
			Date	13/11/2025	
			Version	2.23	Page: 22/120

#### 4.4 Purpose of the software

In 2008, the French Parliament voted the Space Operations Act (Loi sur les Opérations Spatiales, LOS), whose purpose is to set up a national system for authorisation and control of space operations under French jurisdiction. This law was followed by decrees and technical regulations which require that satellites should be subjected to a hazards study including an analysis of survivability on re-entry. This analysis can be carried out for uncontrolled or controlled re-entry at end of life, and also for special launch failure conditions.

CNES has been appointed by the State to certify the hazards studies. CNES must therefore acquire the means necessary for this certification. These means are put at the disposal of manufacturers and operators in the space sector bound by the LOS and are used for certification in all cases.

The DEBRISK software is part of these means and has been developed by CNES since 2009. The development of the DEBRISK tool is due to the necessity for CNES to have independent and justified calculation models, and to put at the disposal of the engineers in charge of the risk calculations or of their verification a qualified tool based on validated models, whose source code is fully mastered by CNES.

DEBRISK is intended to be the CNES tool used to conduct the analyses of the survivability of fragments originating in spacecraft on re-entry into the atmosphere.

The DEBRISK software is a tool for analysis of the ablation of debris from a spacecraft after its destruction on re-entry into the atmosphere. It is based on an object-oriented approach, in which the space object is represented by a set of interconnected basic and complex geometries. A structure of the parent-child type is used to define the relations between these different objects. Each object is defined by its shape, its dimensions, its mass and its material.

The user provides the initial kinematic conditions of the entry of the space object, and the software calculates the trajectory of the fragments and the possible ablation along this trajectory. The software gives a list of surviving objects and their characteristics on landing.

DEBRISK allows the creation of one spacecraft at a time, but of as many child fragments as required.


DEBRISK first calculates the trajectory and the kinematic conditions of the vehicle as a whole between the starting altitude specified by the user and the fragmentation altitude (between 100m and 200 km), considering a loss of solar power plant at 95 km. It then calculates the trajectory (between the fragmentation altitude and the ground) and the possible ablation of the fragments from the spacecraft. These fragments are defined by the user and can be matched as parent/child. Finally, DEBRISK calculates the casualty area of the surviving fragments.

	<p>CNES</p> <p>DEBRISK</p>		Ref.	DBK-MU-LOG-0268-THA	
			Date	13/11/2025	
			Version	2.23	Page: 23/120

To do this, the code solves the fundamental mechanics equation along the descent trajectory. Aerodynamic forces are estimated, for each flight domain, for each object. The heat fluxes encountered by the object for each flight domain are calculated, along with the increase in the temperature of the object. When the temperature of the object has reached the melt temperature, the object is ablated, and the changes in its dimensions and mass are taken into account when calculating the trajectory. The purpose of the DEBRISK tool is to calculate the surviving fragments of a spacecraft during its re-entry into the Earth's atmosphere. It makes it possible to provide this list of fragments to the ELECTRA tool and to calculate the associated casualty area.

The main functions of the DEBRISK software are:

- the calculation of the aerodynamic coefficients of the object,
- the calculation of the trajectory of an object in free fall towards the Earth,
- the calculation of the aerothermodynamic fluxes,
- the calculation of the temperature of the object,
- the calculation of the ablation of the object.

	<p>CNES</p> <p>DEBRISK</p>		Ref.	DBK-MU-LOG-0268-THA	
			Date	13/11/2025	
			Version	2.23	Page: 24/120

## 5 External view of the software

The following folders and files (between brackets) created by the DEBRISK installer are required for DEBRISK to operate:

- 3DModels: Containing the 3D models used for GoogleEarth.
- Database
- Documents : Containing the user manual, methodology guides(in English and in French) and the last release note of current debris risk version.
- Images: Containing the images used by the software-
- Orekit-data: Containing the DE-406-ephemerides
- XSD files for the verification of the XML file structure.
- PDF files containing the user manuals.

	<p>CNES</p> <p>DEBRISK</p>		Ref.	DBK-MU-LOG-0268-THA	
			Date	13/11/2025	
			Version	2.23	Page: 25/120

## 6 Operational environment

### 6.1 General

The DEBRISK software requires the minimal software and hardware configuration described below.

### 6.2 Hardware configuration

It must be possible to execute the DEBRISK software on stations with:

- A monitor with minimum resolution of 1280x1024.
- A graphics card with minimum resolution of 1280x1024.
- An amount of RAM of 2 gigabytes minimum (see note below).
- 100 megabyte of disk space minimum.



Note: After a simulation including dozens of objects, it is recommended not to move on to a 2<sup>nd</sup> simulation without first closing the tab of the 1st simulation, so as not to take up too much memory, with consequences for the execution time.



### 6.3 Software configuration

The stations can be equipped with the following operating systems:

- Windows 7, 8, 10, 11
- Linux REDHAT (Red Hat Enterprise Linux Desktop)
- Linux SUSE (OpenSUSE)

The operation of DEBRISK requires the installation of a JAVA virtual machine version 21 minimum.

The DEBRISK outputs are compatible with:

	<p>CNES</p> <p>DEBRISK</p>		Ref.	DBK-MU-LOG-0268-THA	
			Date	13/11/2025	
			Version	2.23	Page: 26/120

- Tecplot version 8 and later,
- Microsoft Excel 97 and later,
- Google Earth 5.0 and later,
- ELECTRA V4.3 and later.

In addition, Debrisk requires a recent PDF reader (e.g. Adobe Reader available on <http://get.adobe.com/fr/reader/>) in order to read this manual when using the DEBRISK “help” function (accessible by pressing “F1”).

Please, note that the exported files by DEBRISK will be encoded following the UTF-8 format. See 10.3 for more information on this topic

	CNES		Ref.	DBK-MU-LOG-0268-THA		
	DEBRISK		Date	13/11/2025		
			Version	2.23	Page: 27/120	

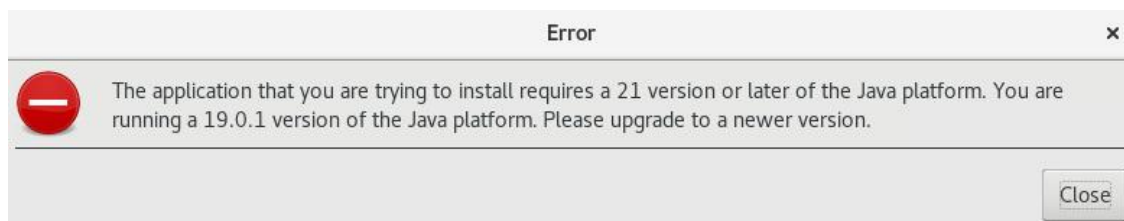
## 7 Operating Manual

### 7.1 Configuration and initialisation

The DEBRISK installer comes in the form of a wizard proposing a limited and intuitive number of options.



The installer specifies whether the Java version installed is incompatible (21 minimum). However, if Java is not installed at all, the installer does not start. Moreover, if the version installed is too old, the following message is displayed (found on JAVA version 19):



In this case, install Java version 21 and restart the installer.

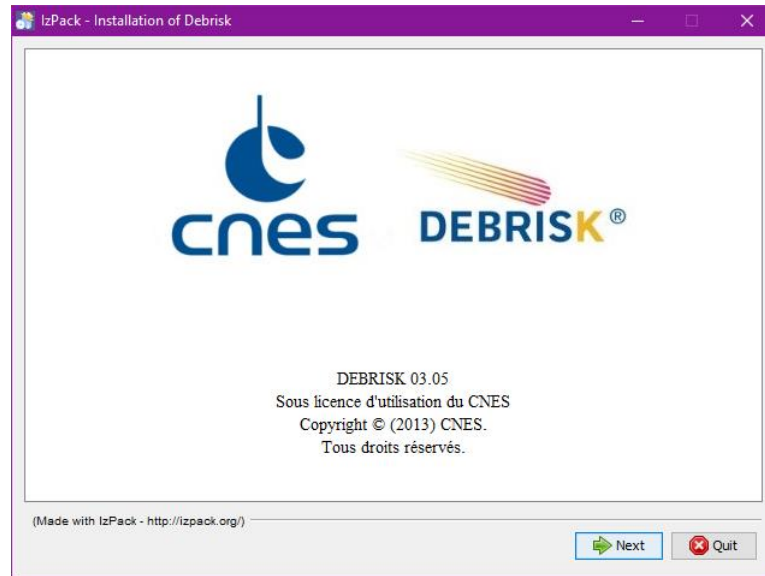
### 7.2 Installation of DEBRISK

The installation is carried out by opening the autoexec installation archive. An installation wizard is opened and proposes to modify the default installation directory. DEBRISK will then be created at the location specified by the user, with an executable “.jar” file inside and all the files necessary to launch DEBRISK.

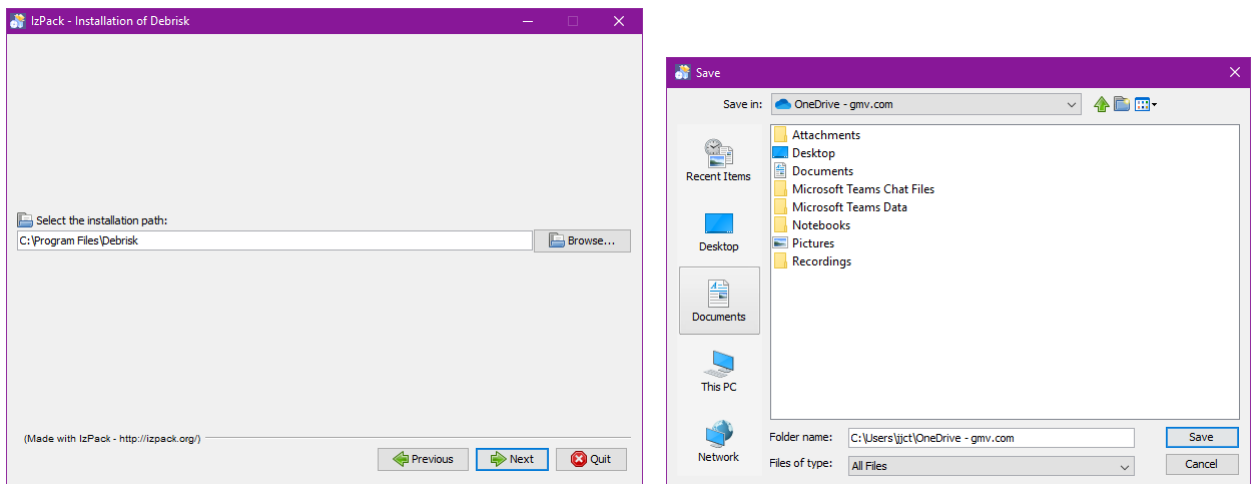
All these files must remain in this installation directory, as they are used by the software to perform the simulations.

The default directory for the input/output files is the “<installation\_directory>/DEBRISK/Database” directory.

	<p>CNES</p> <p>DEBRISK</p>		Ref.	DBK-MU-LOG-0268-THA	
			Date	13/11/2025	
			Version	2.23	Page: 28/120

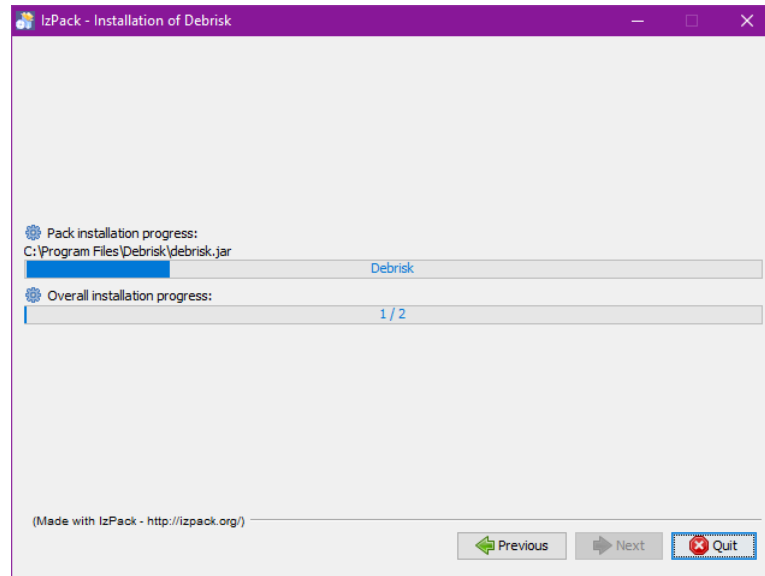


**Figure 1** Opening the wizard.



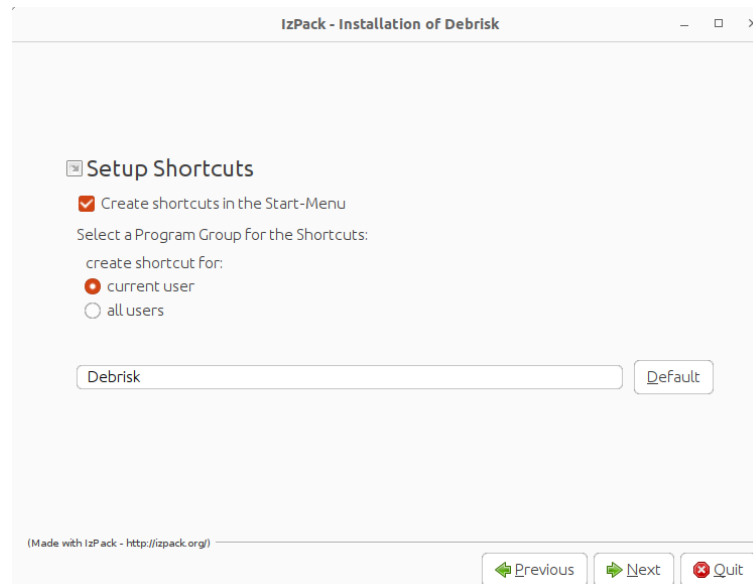
**Figure 2** Selecting the installation directory.

	<p>CNES</p> <p>DEBRISK</p>		Ref.	DBK-MU-LOG-0268-THA	
			Date	13/11/2025	
			Version	2.23	Page: 29/120





**Figure 3 Installation in progress**

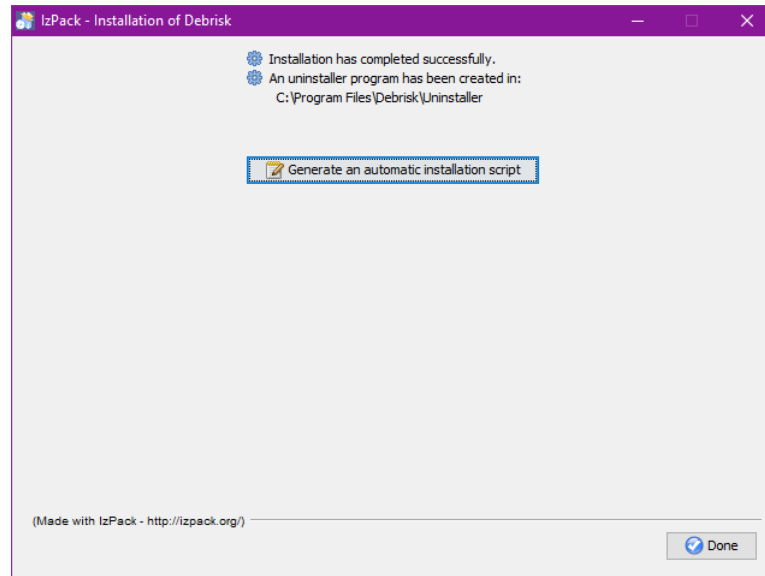
You can choose to create a shortcut on the desktop:



**Figure 4 Selecting a shortcut if required.**

The “Default” button is used to reset the default value of the group of shortcuts (i.e. “Debrisk”), if this had been modified by mistake.

	<p>CNES</p> <p>DEBRISK</p>		Ref.	DBK-MU-LOG-0268-THA	
			Date	13/11/2025	
			Version	2.23	Page: 30/120



**Figure 5 End of the installation**

The “Generate an automatic installation script” button is used to generate a script to be used for an identical installation (useful in case of deployment in a “standard” environment).

When clicking on this button, the installer proposes to save a file which can then be copied from station to station to reproduce the same installation. The installation can then be launched as follows in command line:

« java -jar name\_of\_Debrisk\_installer path\_of\_script ».

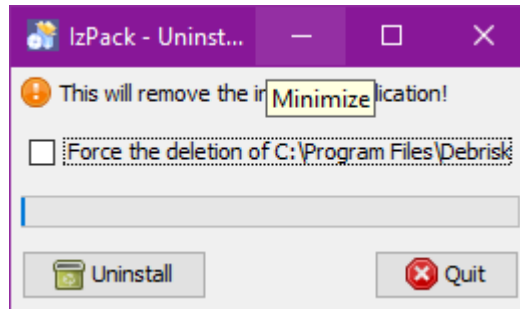
The installation then takes place in silent mode with the same user settings as for the installation which generated this script.

### **7.3 Uninstallation**

To uninstall DEBRISK, execute the “DEBRISK\_INSTALL/Uninstaller/uninstaller.jar” file, where “DEBRISK\_INSTALL” is the DEBRISK installation file.

The following window is displayed:

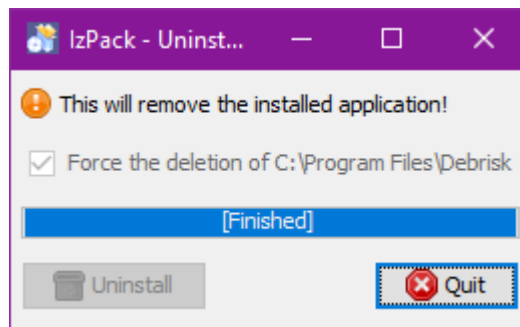
	CNES		Ref.	DBK-MU-LOG-0268-THA	
	DEBRISK		Date	13/11/2025	
			Version	2.23	Page: 31/120



**Figure 6 Uninstallation window**

The “Force the deletion of ...” option is used for the complete deletion of the Debrisk file (including the saved simulations and exports, the user material file or any other file which might be stored there).

Clicking on the “Uninstall” button launches the uninstallation. Click on “Quit” to close the window.



**Figure 7 Uninstallation completed**

## 7.4 Mode selection and control

The DEBRISK software can be used in different modes:

- Standard mode: graphic interface (see chapter 7.5)
- Console mode

### 7.4.1 The console mode

	CNES  DEBRISK		Ref.	DBK-MU-LOG-0268-THA	
			Date	13/11/2025	
			Version	2.23	Page: 32/120

The Debrisk software can be launched using a command line. Execution takes place in batch.

The syntax of the command line is as follows:

```
java -jar debrisk.jar --input xml_input_file_path --output no_extension_output_files_generic_path
[-params] [--debug]
```

params is a combination of one or more value(s) among:

- r : creation of a CSV report
- t : creation of a TECPLOT file
- k : creation of a KML file
- x : creation of an XML file, if the *Create Cb vs Mach file* option is selected the “CbMach” CSV file will be generated with in the same location.
- f : creation of DML file (Flat XML)

For example, the line below:

```
"java -jar debrisk.jar --input /home/xxx/Debrisk/Database/case001.xml --output
/home/xxx/Debrisk/Output/test1 -rtkx"
```

reads and loads the /home/xxx/Debrisk/Database/case001.xml file and creates the following files:

- /home/xxx/Debrisk/Output/test1.csv
- /home/xxx/Debrisk/Output/test1.dat
- /home/xxx/Debrisk/Output/test1.kml
- /home/xxx/Debrisk/Output/test1.xml
- /home/xxx/Debrisk/Output/CbMach\_test1.xml

"-rtkx" here is equivalent to "-r -t -k -x"

The extra "--debug" optional parameter is used to display more information in the logs (see §7.4.2).

	CNES  DEBRISK		Ref.	DBK-MU-LOG-0268-THA	
			Date	13/11/2025	
			Version	2.23	Page: 33/120

The extra “--installDir <DIR>” optional parameter is used to specify the installation directory (<DIR> must here be replaced by the full path of the installation directory selected). By default, it is in the same location as the executable program.

The extra “--userMaterials <FILE>” optional parameter is used to specify the path of the material file (<FILE> must here be replaced by the path of the material file selected) to be used instead of the materials properties defined in the configuration file.

The “--help” command displays the notice of the command line syntaxes mentioned above.

### 7.4.2 The IHM mode

Apart from the desktop icon, the Debrisk software can be launched in IHM mode using a command line from the installation directory. The syntax of the command line is as follows:

```
java -jar debrisk.jar [--installDir <DIR>] [--userMaterials <FILE>] [--debug]
```

The “--installDir <DIR>” is an optional parameter used to specify the installation directory (<DIR> must here be replaced by the full path of the installation directory selected). By default, it is in the same location as the executable program.


The “--userMaterials <FILE>” is an optional parameter used to specify the path of the material file (<FILE> must here be replaced by the path of the material file selected) to be used instead of the materials properties defined in the configuration file.

The “--debug” is an optional parameter used to display more information in the logs (see §7.4.3).

### 7.4.3 Log management

All error messages sent by the application to the user (exception, confirmation, warning, information, etc.) are archived in the form of logs in a “Debrisk.log” file in text format located in the DEBRISK execution directory.

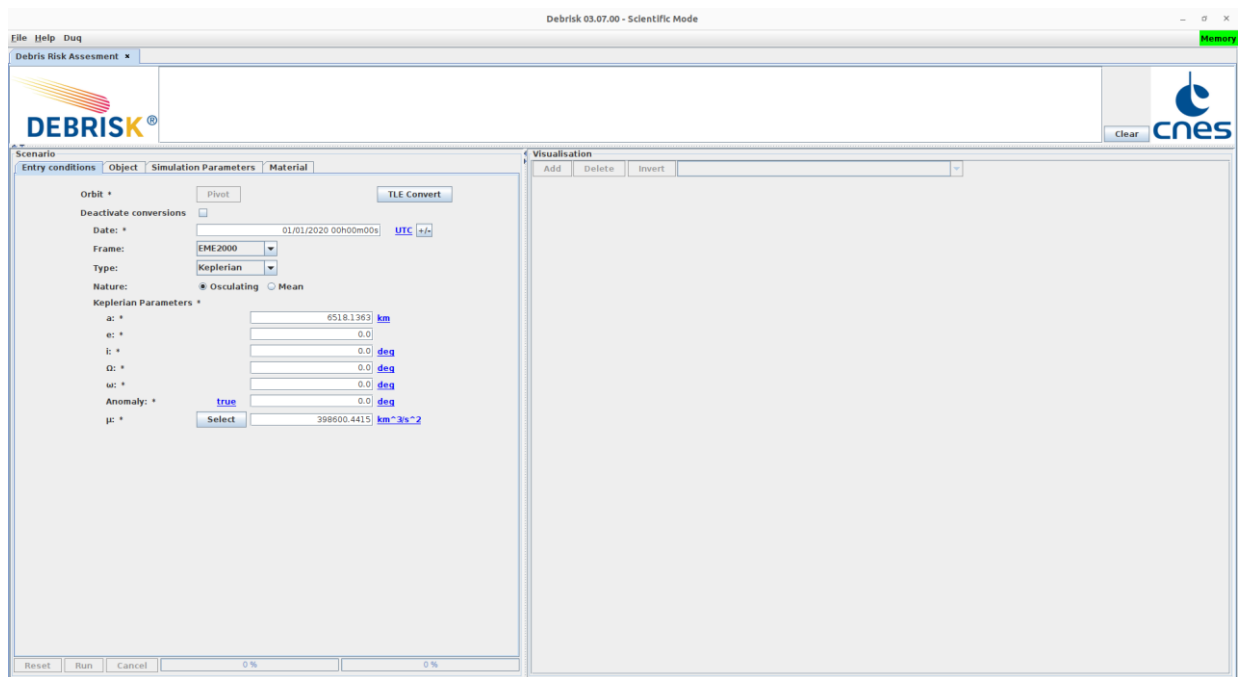
In addition to the normal “user” display, logs of the “DEBUG” type are recorded to save the information generated during the calculation (important variable values, location of the process in progress in the code, etc.). To display these extra logs, the “--debug” parameter must be specified when launching the application (see §7.4.1).

	<p>CNES</p> <p>DEBRISK</p>		Ref.	DBK-MU-LOG-0268-THA	
			Date	13/11/2025	
			Version	2.23	Page: 34/120

## 7.5 Normal operation

### 7.5.1 Graphic interface

In this section, you will learn how to use DEBRISK. When opening the software, the home page should be similar to what you can see below.



**Figure 8 Home page**

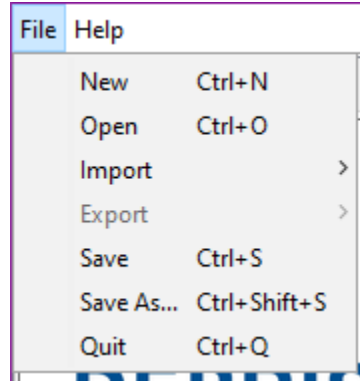
At this stage, it is possible to distinguish between the two main parts of the software, namely:

- the message area on the top,
- the scenario on the left,
- the view of the results on the right.

There is also a main menu accessible in the top left-hand corner.

	<p>CNES</p> <p>DEBRISK</p>		Ref.	DBK-MU-LOG-0268-THA	
			Date	13/11/2025	
			Version	2.23	Page: 35/120

### 7.5.1.1 Menu



**Figure 9 Menu**

	CNES  DEBRISK		Ref.	DBK-MU-LOG-0268-THA	
			Date	13/11/2025	
			Version	2.23	Page: 36/120

The following functions can be accessed from the *File* menu:

“New”: creates a new tab in which you can create or open a new case to be studied.

“Open”: is used to open a previously saved study case.

“Export”: is used to export files to other software packages (Tecplot, Google Earth, CSV).



The *Tecplot*, *Google Earth* and *CSV* files will be encoded following the UTF-8 format. Hence, in order to be able to read it properly, you must use a text editor compatible with UTF-8 (such as notepad++, for instance).

If we want to import the file in Excel or any other program, you must indicate during this process that the file is encoded in UTF-8 format.

“Save”: is used to save the case being studied by including the list of objects, the initial conditions, the simulation parameters, and the material properties. The case will be saved to the location from where it was loaded or saved last. In the case of new cases this menu is disabled until the case is saved for the first time.

“Save As...” equivalent to the menu “Save” but ask systematically for the file location to save.

“Quit”: is used to close the software.

The following functions can be accessed from the *Help* menu:



“Show Help: Opens the Debrisk user manual.

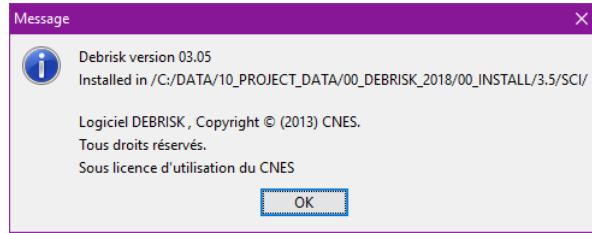
“Show Handbook/Methodology”: Opens the Debrisk methodology guide ( English version)

“Show Handbook/Methodology (French)”: Opens the Debrisk methodology guide ( French version)

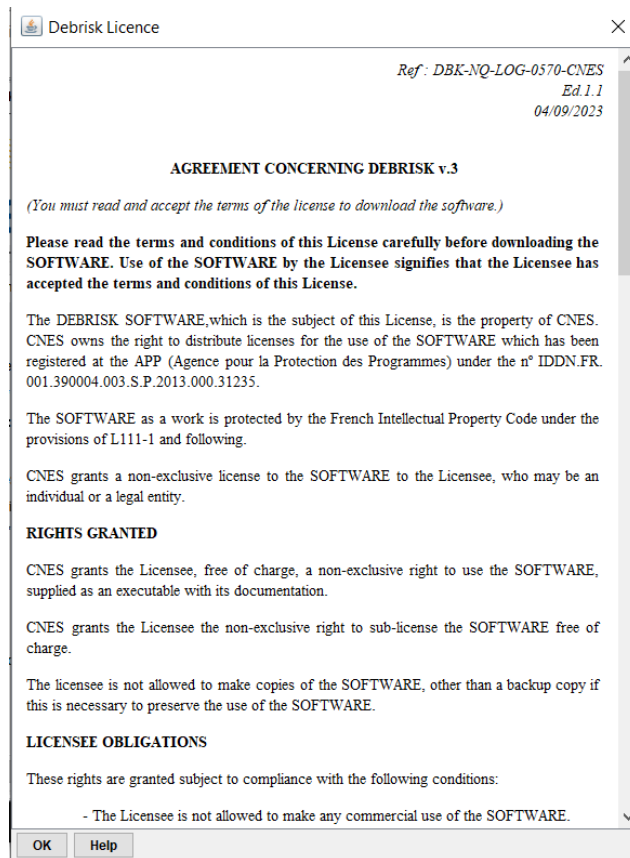
“About”: Shows the dialog containing the program information.

“Show Licence”: Shows the dialog containing the licence.

	<p>CNES</p> <p>DEBRISK</p>		Ref.	DBK-MU-LOG-0268-THA	
			Date	13/11/2025	
			Version	2.23	Page: 37/120



**Figure 10: About dialog.**

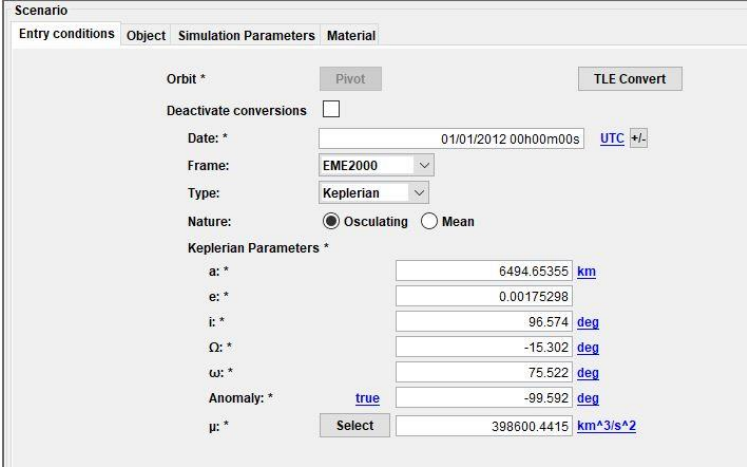


**Figure 11: Licence dialog.**

	CNES  DEBRISK		Ref.	DBK-MU-LOG-0268-THA	
			Date	13/11/2025	
			Version	2.23	Page: 38/120

### 7.5.1.2 Scenario area

Entry conditions:



The screenshot shows the 'Scenario' window with the 'Entry conditions' tab selected. The interface includes the following elements:

- Orbit \***: A 'Pivot' button and a 'TLE Convert' button.
- Deactivate conversions**: A checkbox that is currently unchecked.
- Date: \***: An input field containing '01/01/2012 00h00m00s' and a 'UTC +/-' button.
- Frame:**: A dropdown menu set to 'EME2000'.
- Type:**: A dropdown menu set to 'Keplerian'.
- Nature:**: Radio buttons for 'Osculating' (selected) and 'Mean'.
- Keplerian Parameters \***:
  - a: \***: Input field with '6494.65355' and unit 'km'.
  - e: \***: Input field with '0.00175298'.
  - i: \***: Input field with '96.574' and unit 'deg'.
  - Ω: \***: Input field with '-15.302' and unit 'deg'.
  - ω: \***: Input field with '75.522' and unit 'deg'.
  - Anomaly: \***: A 'true' button and an input field with '-99.592' and unit 'deg'.
  - μ: \***: A 'Select' button and an input field with '398600.4415' and unit 'km<sup>3</sup>/s<sup>2</sup>'.


Figure 12 Scenario area

You will find various tabs in this area. The first one, named “Entry conditions”, must be filled in with the general parameters of the initial point corresponding to the kinematic conditions of the spacecraft to be studied.

Allows you to define an orbit with an absolute date, a frame, an orbital parameter type, an orbital parameter collection, and the necessary celestial constants. This is the equivalent widget to the *Orbit class* in PATRIUS.

It has the following graphical components:

- A label ( *copy/paste/import/export menu* attached).
- A pivot button.
- A checkbox to block/unblock conversions.
- An input field for the date
- A selector of the frame
- A drop-down list to choose the type of orbital parameters:
  - Available options: All types available in PATRIUS: “ Keplerian ”, “ Cartesian ”, “ Circular ”, “ Equinoctial ”, “Equatorial”, “ Apsis Radius”, “ Apsis Altitude”, “ Reentry ”.

	CNES  DEBRISK		Ref.	DBK-MU-LOG-0268-THA	
			Date	13/11/2025	
			Version	2.23	Page: 39/120

## The concept of “pivot”

This widget is actually quite complex as it offers many different parameter frames and types but also allows for conversions. It is very interesting for example if you want to quickly see at what altitude your perigee is when you initially get Cartesian parameters!

Frame:    
 Type:

Cartesian Parameters \*


x: *	<input type="text" value="3295.70380176292"/>	<a href="#">km</a>
y: *	<input type="text" value="5883.65017359001"/>	<a href="#">km</a>
z: *	<input type="text" value="439.631391348975"/>	<a href="#">km</a>
Vx: *	<input type="text" value="-6.74200496491514"/>	<a href="#">km/s</a>
Vy: *	<input type="text" value="3.90930999706841"/>	<a href="#">km/s</a>
Vz: *	<input type="text" value="0.439250454593903"/>	<a href="#">km/s</a>
$\mu$ : *	<input type="text" value="398600.4415"/>	<a href="#">km<sup>3</sup>/s<sup>2</sup></a>

Frame:    
 Type:

Apsis Altitude Parameters \*

hp:	<input type="text" value="200.0"/>	<a href="#">km</a>
ha:	<input type="text" value="300.0"/>	<a href="#">km</a>
i:	<input type="text" value="5.0"/>	<a href="#">deg</a>
$\Omega$ : *	<input type="text" value="10.0"/>	<a href="#">deg</a>
$\omega$ : *	<input type="text" value="20.0"/>	<a href="#">deg</a>
Anomaly:	<input type="text" value="30.0"/>	<a href="#">deg</a>
$\mu$ :	<input type="text" value="398600.4415"/>	<a href="#">km<sup>3</sup>/s<sup>2</sup></a>
req:	<input type="text" value="6378.1363"/>	<a href="#">km</a>

Unfortunately, feedback from several years of use shows that you will definitely get numerical uncertainties and when you have to go back to the first input, you will not get back exactly the same values.

	CNES  DEBRISK		Ref.	DBK-MU-LOG-0268-THA	
			Date	13/11/2025	
			Version	2.23	Page: 40/120

The "pivot" is a very important concept that allows us to answer this problem. The basic idea is to store the initial entry in the form of a reference (the "pivot"). Thus, each time the user requests a conversion, it will be checked whether the format is equal (or not) to the reference. If this is the case, no conversion will be performed, the reference will be retrieved. The "pivot" is then defined by:

- The frame
- The type of parameters
- The type of anomaly (if any)

At any time, the user can modify the definition of the “ **pivot** ” by clicking on the dedicated button.

On the other hand, if the user changes a value (like the eccentricity in Keplerian parameters), the " **pivot** " will be automatically changed (because we will be on a new orbit). In the same idea, if the user changes the " $\mu$ " value (or the equatorial radius or the flatness), the orbit will also be changed. Nevertheless, a conversion will be done because it could be useful to see the influence of such constants.

Moreover, it is always possible to disconnect this conversion possibility: indeed, this is a basic case where the user started entering orbital parameters before choosing the right reference!

The pivot button is not enabled at all times. The following conditions must be true for it to be enabled:

- The widget must be enabled.
- The orbit must not be in error.
- The checkbox to block conversions must not be enabled.
- The widget does not show the “Pivot” data
- The parameters are not zero.

The “Pivot” is updated with the current widget data in the following cases:

- When the user clicks the pivot button.
- When the date, one of the orbital parameters, or one of the celestial constants are changed.
- When conversions are blocked (checkbox is checked) and:
  - The user changes the frame.
  - The user changes the type of parameters.
- When you uncheck the box to block conversions.
- When assigning the widget with an *Orbit object* .
- When reading a configuration by file.
- When we clear the widget.

As soon as the user selects a different landmark, a different parameter type, or a different anomaly type (if possible), the orbital parameter collection is updated, but the "Pivot" is not updated.


	CNES  DEBRISK		Ref.	DBK-MU-LOG-0268-THA	
			Date	13/11/2025	
			Version	2.23	Page: 41/120

If at any point the user enters a combination of data that results in an error status, the frame selector, parameter type selector, and pivot button are disabled (unless the checkbox to disable conversions is checked) until the data is corrected, to avoid freezing an invalid "Pivot".

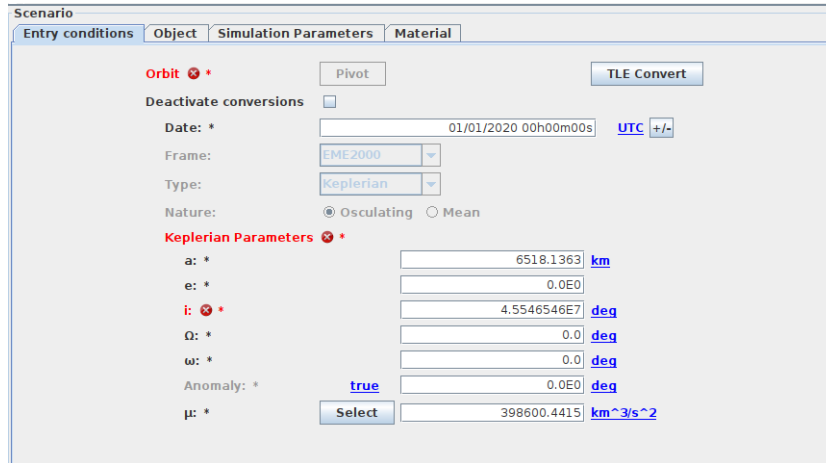
The checkbox to block conversions is used for precisely that: when it is checked, if the user changes the reference frame, the anomaly type or modifies one of the celestial constants, the six orbital parameters do not change, are not recalculated. After a change of the parameter type, as the parameter collection changes, they are all reset to zero. This feature makes it easier to reconfigure the widget if, for example, you started to enter a bulletin but you realize that you were not in the right reference frame.



The date entered is limited by the ephemeris data files available in the orekit-data/DE-406-ephemerides/ folder in the DEBRISK installation folder. Each file contains data for 300 years from the date mentioned in the file name (e.g. unxp1800.406 contains the data for the years 1800 to 2100). DEBRISK is therefore installed with the data for the years 1800 to 3000. If the date entered is outside this bracket, a message informs the user that simulation is not possible and prompts him to download the data files containing the years for which he wants to conduct a simulation. These files are available on <ftp://ssd.jpl.nasa.gov/pub/eph/planets/SunOS/de406/>.

	<p>CNES</p> <p>DEBRISK</p>		Ref.	DBK-MU-LOG-0268-THA	
			Date	13/11/2025	
			Version	2.23	Page: 42/120

The values of the entry conditions will be verified for coherence, if the values are not coherent the parameters color turns red:



Scenario

Entry conditions | Object | Simulation Parameters | Material

Orbit ✖ \*

Pivot TLE Convert

Deactivate conversions

Date: \* 01/01/2020 00h00m00s UTC +/-

Frame: EME2000

Type: Keplerian

Nature:  Osculating  Mean

Keplerian Parameters ✖ \*

a: \* 6518.1363 km

e: \* 0.0E0

i: ✖ \* 4.5546546E7 deg


Ω: \* 0.0 deg

ω: \* 0.0 deg

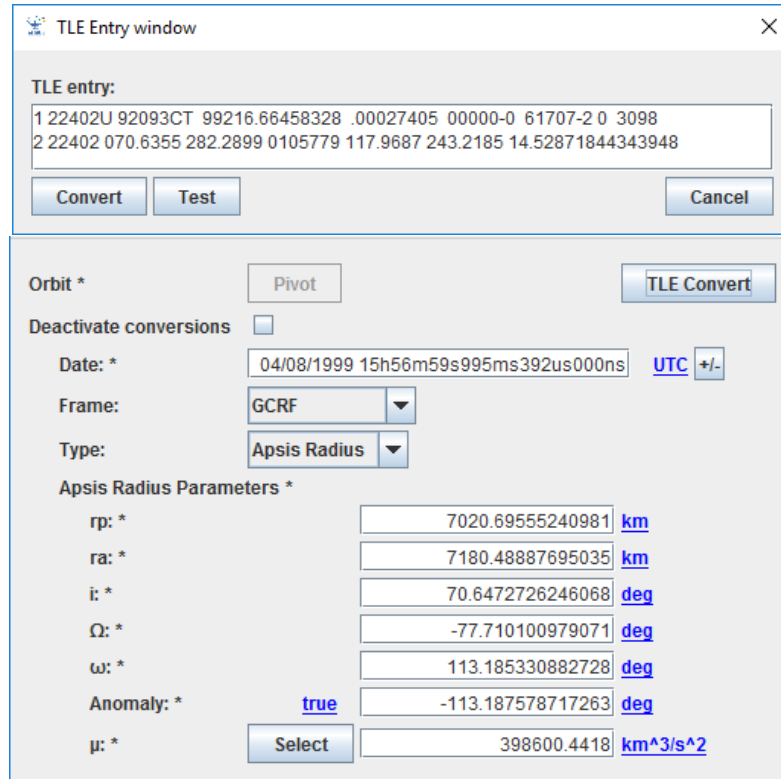
Anomaly: \* true 0.0E0 deg

μ: \* Select 398600.4415 km<sup>3</sup>/s<sup>2</sup>

**Figure 13** orbit containing the incoherences.

	CNES  DEBRISK		Ref.	DBK-MU-LOG-0268-THA	
			Date	13/11/2025	
			Version	2.23	Page: 43/120

There is the possibility to enter data from a TLE by clicking on the dedicated button. This data will be automatically converted into osculating parameters



The image shows two screenshots of a software interface. The top screenshot is a 'TLE Entry window' with a text box containing two lines of TLE data: '1 22402U 92093CT 99216.66458328 .00027405 00000-0 61707-2 0 3098' and '2 22402 070.6355 282.2899 0105779 117.9687 243.2185 14.52871844343948'. Below the text box are 'Convert', 'Test', and 'Cancel' buttons. The bottom screenshot shows the 'TLE Convert' dialog. It has a 'Pivot' button and a 'TLE Convert' button. There is a 'Deactivate conversions' checkbox. The 'Date' field is '04/08/1999 15h56m59s995ms392us000ns' with a 'UTC +/-' button. The 'Frame' dropdown is 'GCRF' and the 'Type' dropdown is 'Apsis Radius'. Under 'Apsis Radius Parameters \*', there are input fields for 'rp: \*' (7020.69555240981 km), 'ra: \*' (7180.48887695035 km), 'i: \*' (70.6472726246068 deg), 'Ω: \*' (-77.710100979071 deg), 'ω: \*' (113.185330882728 deg), 'Anomaly: \*' (true, -113.187578717263 deg), and 'μ: \*' (398600.4418 km^3/s^2) with a 'Select' button.

### 7.5.1.3 Objects tab

The object tab allows you to add new objects using the *Add* button, to edit some objects already created using the *Edit* button, to duplicate objects using the *Duplicate* button, to delete them using the *Delete* button and to change from input to output display –and vice versa- after having run a configuration using the *Swap* button.

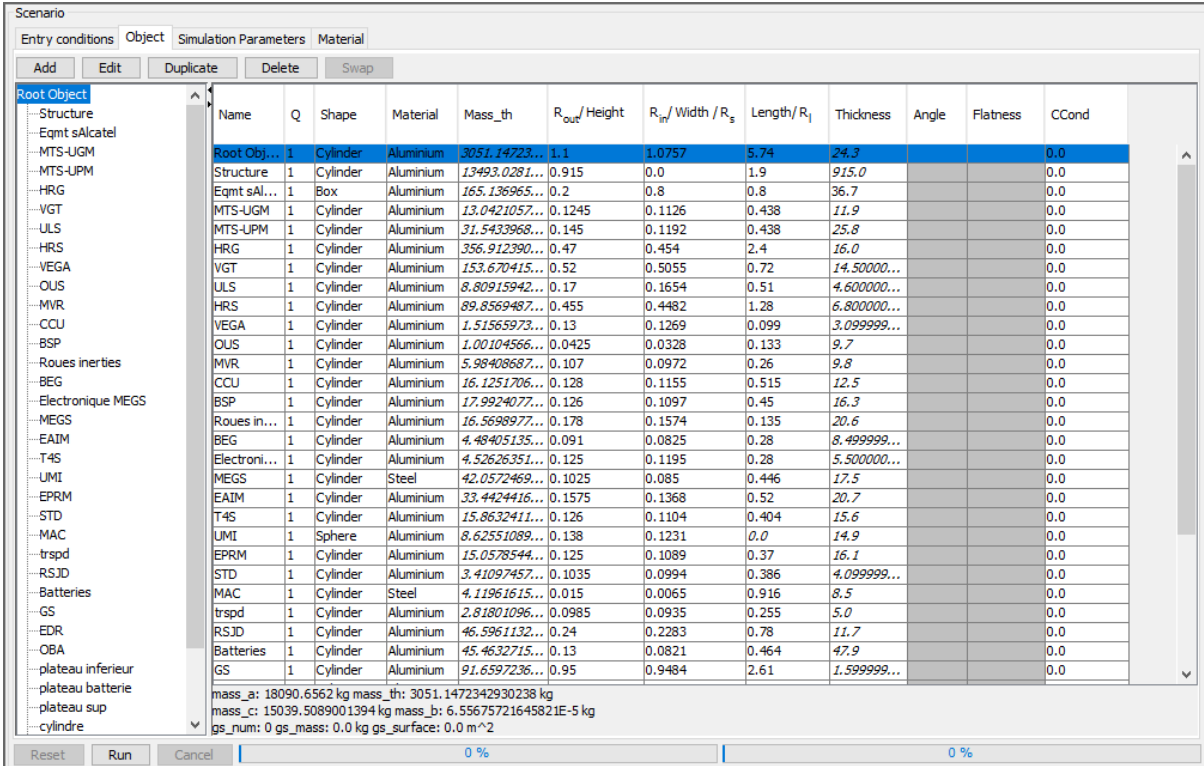
When clicking on “Duplicate”, the whole group of children, grandchildren,... of the selected object will also be duplicated.

The activation of these buttons works according to the following logic:

- “Add” button follows the same logic than the “Run” button.
- “Delete” button is active whenever the “Run” button is enabled and at least one row is selected in the object table.
- “Duplicate”/”Edit” buttons are active when the “Run” button is enabled and if **one** row is selected in the object table.

- “Swap” button is only active when results of a computation are available i.e. whenever the “Reset” button is enabled

In the left part, you can see a tree representing the overall structure of the case you are about to simulate. The indentation of the elements in this tree shows the parent-child links existing between the different objects. This tree offers the user the possibility to drag and drop any object into another one: the latter will automatically become the parent of the selected object and the table will be properly updated with the new information. From a practical point of view, the user is not allowed to move an object downwards along the same branch since it does not add any physical meaning to the problem.




Name	Q	Shape	Material	Mass_th	R <sub>out</sub> /Height	R <sub>in</sub> /Width/R <sub>s</sub>	Length/R <sub>l</sub>	Thickness	Angle	Flatness	CCond
Root Obj...	1	Cylinder	Aluminium	3051.14723...	1.1	1.0757	5.74	24.3			0.0
Structure	1	Cylinder	Aluminium	13493.0281...	0.915	0.0	1.9	915.0			0.0
Eqmt sAlcatel	1	Box	Aluminium	165.136965...	0.2	0.8		36.7			0.0
MTS-UGM	1	Cylinder	Aluminium	13.0421057...	0.1245	0.1126	0.438	11.9			0.0
MTS-UPM	1	Cylinder	Aluminium	31.5433968...	0.145	0.1192	0.438	25.8			0.0
HRG	1	Cylinder	Aluminium	356.912390...	0.47	0.454	2.4	16.0			0.0
VGT	1	Cylinder	Aluminium	153.670415...	0.52	0.5055	0.72	14.50000...			0.0
ULS	1	Cylinder	Aluminium	8.80915942...	0.17	0.1654	0.51	4.600000...			0.0
HRS	1	Cylinder	Aluminium	89.8569487...	0.455	0.4482	1.28	6.800000...			0.0
VEGA	1	Cylinder	Aluminium	1.51565973...	0.13	0.1269	0.099	3.099999...			0.0
OUS	1	Cylinder	Aluminium	1.00104566...	0.0425	0.0328	0.133	9.7			0.0
MVR	1	Cylinder	Aluminium	5.98408687...	0.107	0.0972	0.26	9.8			0.0
CCU	1	Cylinder	Aluminium	16.1251706...	0.128	0.1155	0.515	12.5			0.0
BSP	1	Cylinder	Aluminium	17.9924077...	0.126	0.1097	0.45	16.3			0.0
Roues in...	1	Cylinder	Aluminium	16.5698977...	0.178	0.1574	0.135	20.6			0.0
BEG	1	Cylinder	Aluminium	4.48405135...	0.091	0.0825	0.28	8.499999...			0.0
Electroni...	1	Cylinder	Aluminium	4.52626351...	0.125	0.1195	0.28	5.500000...			0.0
MEGS	1	Cylinder	Steel	42.0572469...	0.1025	0.085	0.446	17.5			0.0
EAIM	1	Cylinder	Aluminium	33.4424416...	0.1575	0.1368	0.52	20.7			0.0
T4S	1	Cylinder	Aluminium	15.8632411...	0.126	0.1104	0.404	15.6			0.0
UMI	1	Sphere	Aluminium	8.62551089...	0.138	0.1231		14.9			0.0
EPRM	1	Cylinder	Aluminium	15.0578544...	0.125	0.1089	0.37	16.1			0.0
STD	1	Cylinder	Aluminium	3.41097457...	0.1035	0.0994	0.386	4.099999...			0.0
MAC	1	Cylinder	Steel	4.11961615...	0.015	0.0065	0.916	8.5			0.0
trspd	1	Cylinder	Aluminium	2.81801096...	0.0985	0.0935	0.255	5.0			0.0
RSJD	1	Cylinder	Aluminium	46.5961132...	0.24	0.2283	0.78	11.7			0.0
Batteries	1	Cylinder	Aluminium	45.4632715...	0.13	0.0821	0.464	47.9			0.0
GS	1	Cylinder	Aluminium	91.6597236...	0.95	0.9484	2.61	1.599999...			0.0

mass\_a: 18090.6562 kg mass\_th: 3051.1472342930238 kg  
mass\_c: 15039.5089001394 kg mass\_b: 6.55675721645821E-5 kg  
gs\_num: 0 gs\_mass: 0.0 kg gs\_surface: 0.0 m^2

Figure 14 Object tab

Below the objects table, before the simulation, the satellite mass decomposition is displayed:

- mass\_a: aerodynamic mass of the satellite (kg)
- mass\_b: ballast mass (kg)
- mass\_c: mass of the satellite children (kg)
- mass\_th: thermal mass of the satellite (kg)
- gs\_num: number of solar generators.
- gs\_mass: total mass of the solar generators.
- gs\_surface: total surface of the solar generators.

	CNES  DEBRISK		Ref.	DBK-MU-LOG-0268-THA	
			Date	13/11/2025	
			Version	2.23	Page: 45/120

```
mass_a: 3.9062430245E6 kg mass_th: 4.9608600000000001E-4 kg
mass_c: 3.50594200318252E6 kg mass_b: 400301.020821391 kg
gs_num: 0 gs_mass: 0.0 kg gs_surface: 0.0 m^2
```

**Figure 15: Total casualty area after a simulation reset.**

If the ballast mass is negative, it will be displayed in red.

```
mass_a: 1.9062430245E6 kg mass_th: 4.9608600000000001E-4 kg
mass_c: 3.50594200318252E6 kg mass_b: -1.59969897917861E6 kg
gs_num: 0 gs_mass: 0.0 kg gs_surface: 0.0 m^2
```

**Figure 16: Negative ballast mass.**

After the simulation, the total casualty area (corresponding to the addition of the casualty area of all the fragments) ) and the total weighted casualty area will be displayed below the objects table:

LIMIT	1	62524.77	0.0	0.0
<				
Total Casualty Area: 45.616 m2				
Total Weighted Casualty Area: 31.342 m2				

**Figure 17: Total casualty area value after an execution.**



If a configuration file without satellite aerodynamic mass (i.e. from a previous version) is opened, the satellite aerodynamic mass is computed by adding the satellite thermal mass and the mass of solar panels. This case will generally lead to a negative ballast mass.

	<p>CNES</p> <p>DEBRISK</p>		Ref.	DBK-MU-LOG-0268-THA	
			Date	13/11/2025	
			Version	2.23	Page: 46/120

## Creation of objects

Please note that the first object in the list is always a spacecraft, while the others are always fragments. The spacecraft can only be modelled by a box, a cylinder or a sphere, and solar panels can be added.

To add an object, select a parent object in the tree or the table and click on the *Add* button. A new window is displayed:

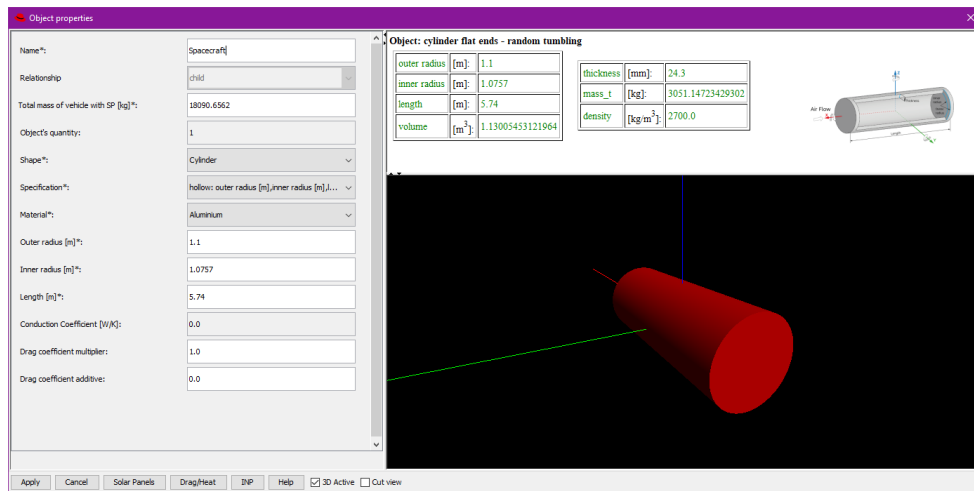


Figure 18 Adding a root object window.

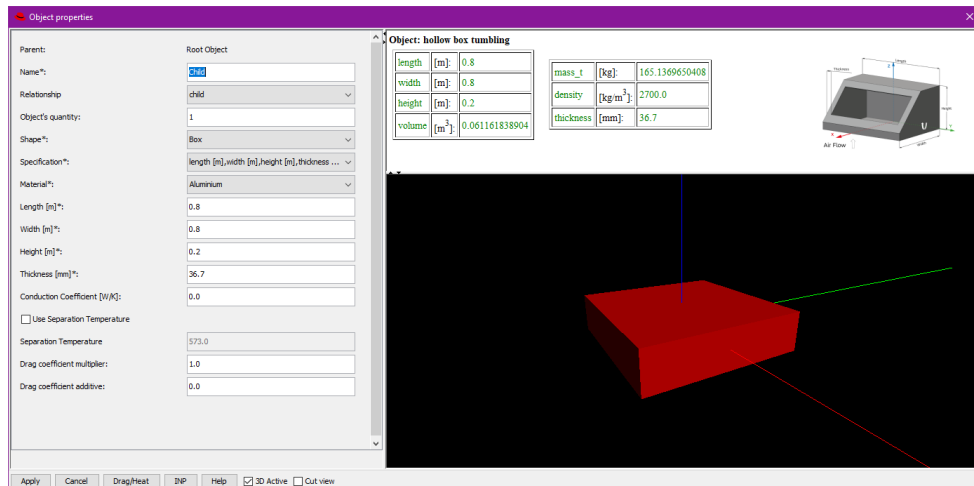


Figure 19 Adding an object window.

	CNES  DEBRISK		Ref.	DBK-MU-LOG-0268-THA	
			Date	13/11/2025	
			Version	2.23	Page: 47/120

In this window, you are asked to enter the following elements:

- Parent: contains the name of the object parent of the one being created (for the spacecraft this field is not displayed).
- Name: allowing to insert the name of the object.




The name of the object cannot contain the character “#”, using this character makes the object invalid.

- Relationship: menu to indicate if we are creating a “component” or a standard “child”, for more details see “creation of components” paragraph below.
- Object’s quantity: this parameter is used when the operator wants to define several fragments with the exact same characteristics. Even if  $Q > 1$ , a single simulation will be run for the fragment.  
This value will only be used to compute the aerodynamic mass of an object having children with  $Q = 1$  and for the casualty area (which will be computed as the casualty area of the simulated fragment multiplied by  $Q$ ).
- Shape: selection of the shape of the object.
- Specification: selection of the mode to enter the dimensions of the object according to the data at your disposal. All the other data will be calculated by DEBRISK so that they correspond to the data provided by the user.
- Material: the material of the object to be selected in the list.
- Dimensions to be complemented according to the mode selected beforehand. If mass is one of the required dimensions, the thermal mass of the object is expected. The other dimensions are derived from the first ones and all the dimensions are displayed in the table on the right of the “Object properties” window.
- For the satellite only, the aerodynamic mass corresponding to:

$$aerodynamic\_mass = thermal\_mass + ballast\_mass + children\_mass + solar\_generators\_mass$$

The *ballast\_mass* is then calculated automatically by DEBRISK as:

	CNES		Ref.	DBK-MU-LOG-0268-THA		
	DEBRISK		Date	13/11/2025		
			Version	2.23	Page: 48/120	

$$ballast\_mass = aerodynamic\_mass - (therma\_mass + children\_mass + solar\_generators\_mass)$$

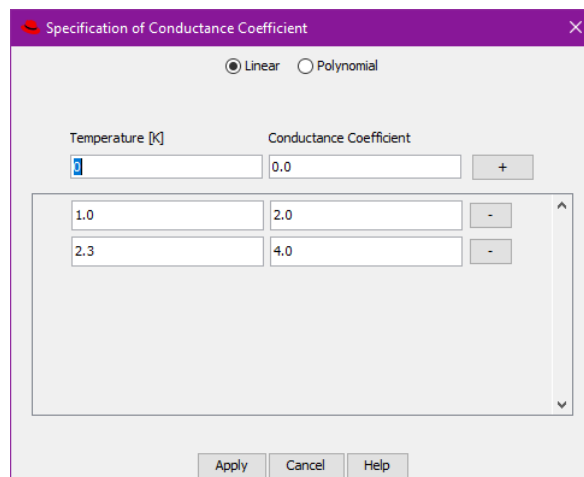
The *ballast\_mass* is displayed below the object table.

For other objects, the aerodynamic mass is not displayed but is computed by Debrisk taking into account the quantity of unborn children of the fragment to be simulated. This value is computed recursively:

$$Aerodynamic\_mass = thermal\_mass\_of\_fragment + \sum (child\_mass * child\_quantity * (child\_child\_mass * child\_child\_quantity ...))$$

- Conduction coefficient: This coefficient represents the thermal conductance between an object and its parent object. It only applies to objects which are in contact. It can be defined for any object except the root object (satellite). The definition of the conduction coefficient can be done following a Linear or a Polynomial model.

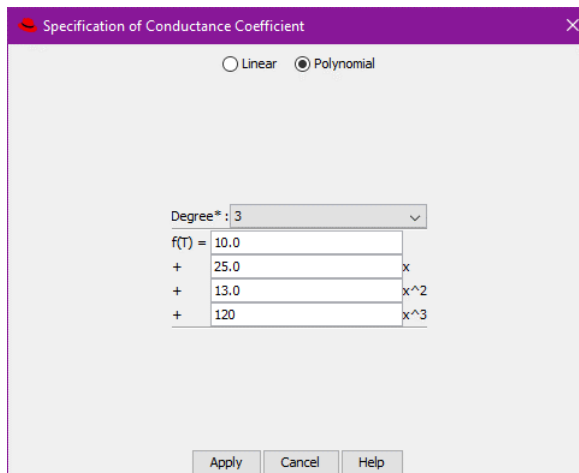
In the Linear case, the first number in each pair is the temperature, and the second corresponds to the value of the conductance coefficient. In this mode, a straight line is drawn between each pair of values.



**Figure 20 : Linear model for conductance**

If you prefer to use the polynomial form, you must specify the degree of the polynomial and provide the coefficients. If you enter only one coefficient, this means that the parameter is constant over the whole temperature range.

	CNES  DEBRISK		Ref.	DBK-MU-LOG-0268-THA	
			Date	13/11/2025	
			Version	2.23	Page: 49/120



**Figure 21 : Polynomial model for conductance**


If no value is entered, the conductance coefficient value is the default value: 0.

Solar panels can be added on the root object (satellite) using the “solar panels” button, which is only displayed on the window for this object.

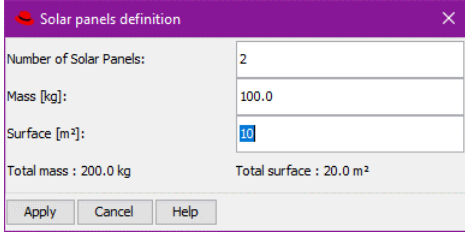
- Separation temperature

The user can choose to specify a temperature beyond which the object will automatically be considered fully ablated. To do so, the user can check the “use separation temperature” box and specify the separation temperature.

When an object has the "separation temperature" criterion activated, then all its children of type component who also have "separation temperature" criterion activated must have a higher separation temperature than their parent. Otherwise, they will be considered invalid and displayed in red.

	<p>CNES</p> <p>DEBRISK</p>		Ref.	DBK-MU-LOG-0268-THA	
			Date	13/11/2025	
			Version	2.23	Page: 50/120

You can then specify the number of solar panels, the mass and the unit surface of the panels.



The dialog box 'Solar panels definition' contains the following fields and values:

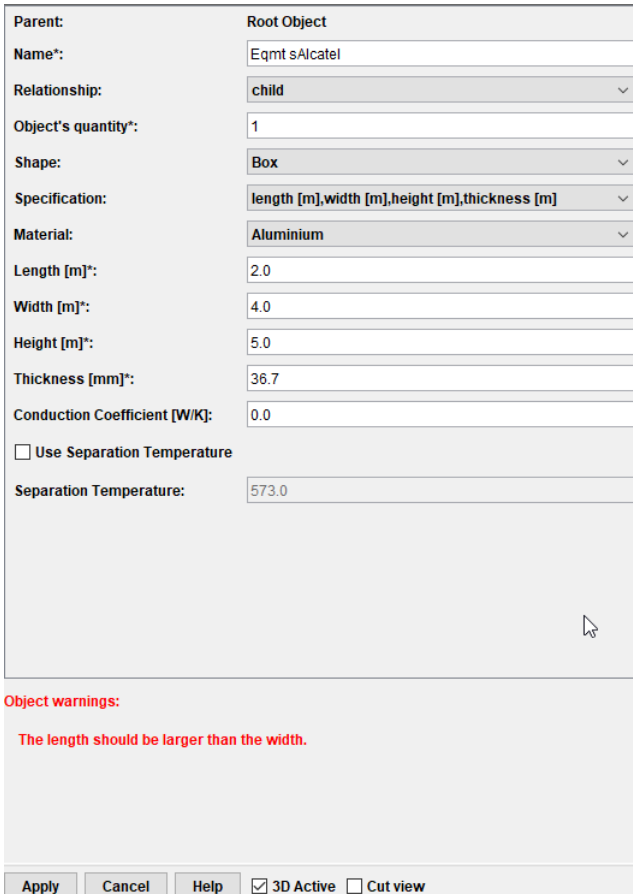
- Number of Solar Panels: 2
- Mass [kg]: 100.0
- Surface [m<sup>2</sup>]: 10
- Total mass : 200.0 kg
- Total surface : 20.0 m<sup>2</sup>

Buttons: Apply, Cancel, Help

**Figure 22 Adding solar panels**

Finally, click on Apply to create the object or on Cancel to cancel the creation.

The values of the object will be verified for coherence, if the values are not coherent a message containing the incoherences is displayed at the bottom of the dialog and if the user applies a confirmation dialog will be displayed:



The dialog box shows the following configuration for a 'Root Object':


- Parent: Root Object
- Name\*: Eqmt sAlcatel
- Relationship: child
- Object's quantity\*: 1
- Shape: Box
- Specification: length [m],width [m],height [m],thickness [m]
- Material: Aluminium
- Length [m]\*: 2.0
- Width [m]\*: 4.0
- Height [m]\*: 5.0
- Thickness [mm]\*: 36.7
- Conduction Coefficient [W/K]: 0.0
- Use Separation Temperature
- Separation Temperature: 573.0

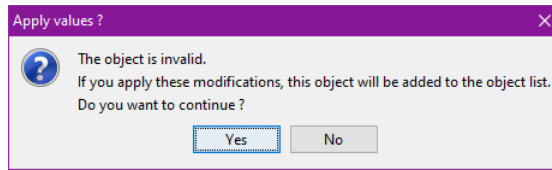
**Object warnings:**

The length should be larger than the width.

Buttons: Apply, Cancel, Help,  3D Active,  Cut view

**Figure 23 Incoherence dimensions dialog**

	CNES  DEBRISK		Ref.	DBK-MU-LOG-0268-THA	
			Date	13/11/2025	
			Version	2.23	Page: 51/120



**Figure 24: confirmation dialog**

In this case the user has the option to continue the edition of the object or accept the incoherence, in the latter case the object line will be displayed in red in the object table.

Name	Q	Shape	Material	Mass_t	Rout/ Height	Rin/ Width	Length	Thickness	CCond	xCd	+Cd
Spacecraft	1	Cylinder	Aluminium	-65904.0794	1.1	1.5	5.74	-400.0	0.0	1.0	0.0
Structure	1	Cylinder	Aluminium	13493.0281	0.915	0.0	1.9	915.0	0.0	1.0	0.0

**Figure 25 Display of an incoherent object**



When you click on an object in the tree, the corresponding object in the table will be selected, and vice versa.

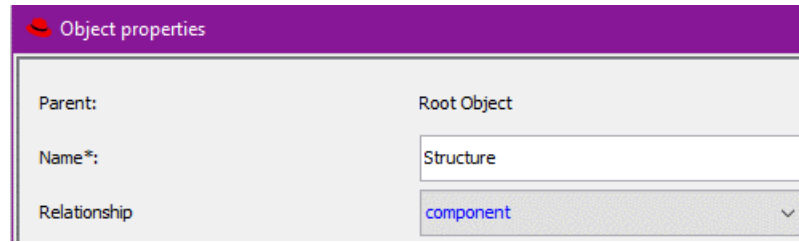
### **Creation of components**

A component is a type of object that has the following characteristics:

- A component cannot have children.
- The mass of a component is not taken into account in the aerodynamic mass of the parent.
- A component does not participate to the conduction heat fluxes.
- The spacecraft cannot be a component.
- When the parent disappears, the component will only be born if the parent's disappearance is due to the fact that it reached its separation temperature. Otherwise (in case of ablation, for instance), the component will not be born.
- When a component is born, its temperature equals its parent's separation temperature.

A component can be created by selecting "component" in the "Relationship" menu in the object properties window.

	CNES		Ref.	DBK-MU-LOG-0268-THA	
	DEBRISK		Date	13/11/2025	
			Version	2.23	Page: 52/120



Object properties

Parent: Root Object

Name\*: Structure

Relationship: component

**Figure 26: Relationship menu**

When created, a component appears in blue in the objects tree on the left side of the objects table if a separation temperature has been defined for its parent. Otherwise, it is displayed in grey and will never be born.

If a component has descendants, they can only be of component type, otherwise the component will be displayed in red and considered invalid.

The spacecraft object cannot be of component type, otherwise it will be displayed in red and considered invalid.

	CNES  DEBRISK		Ref.	DBK-MU-LOG-0268-THA	
			Date	13/11/2025	
			Version	2.23	Page: 53/120

## The objects table

When you click on an object in the tree, the corresponding object in the table will be selected, and vice versa.

In the table you will find the following information:

- Name: object name, only used to track objects during data post-processing.
- Quantity of fragments: This parameter is used when the operator wants to define several fragments with the exact same characteristics. Even if  $Q > 1$ , a single simulation will be run for the fragment. This value will only be used to compute the aerodynamic mass of an object having children with  $Q = 1$  and for the casualty area (which will be computed as the casualty area of the simulated fragment multiplied by  $Q$ )
- Shape: shows the geometry selected to represent this object. This can be a sphere, a box, a cylinder, etc. All the geometries and associated parameters are presented later in this manual.
- Material: shows the material used for the object
- Mass\_th: shows the mass of the object itself, without taking the mass of the children into account. This mass therefore corresponds to the thermal mass in the software, as it is the mass used in thermal equations.
- Rout/Height, Rin/Width/Rs Length/Rl and Thickness, Angle, Flatness: dimensions of the object. The dimension presented in the column depends on the type of object considered. If you run the mouse over the column header, you can view the dimension presented according to the shape. The Angle and Flatness columns apply only to complex shapes, for simple shapes they will be greyed out.
- CCond: Conduction coefficient that will be applied to the computation of the conduction flux.

In this table, double-clicking on one of the cells allows you to edit the corresponding data of the object, unless you double-click on the “name” column, in which case you can only edit the object name. Note that Shape cells cannot be edited in the objects tab.

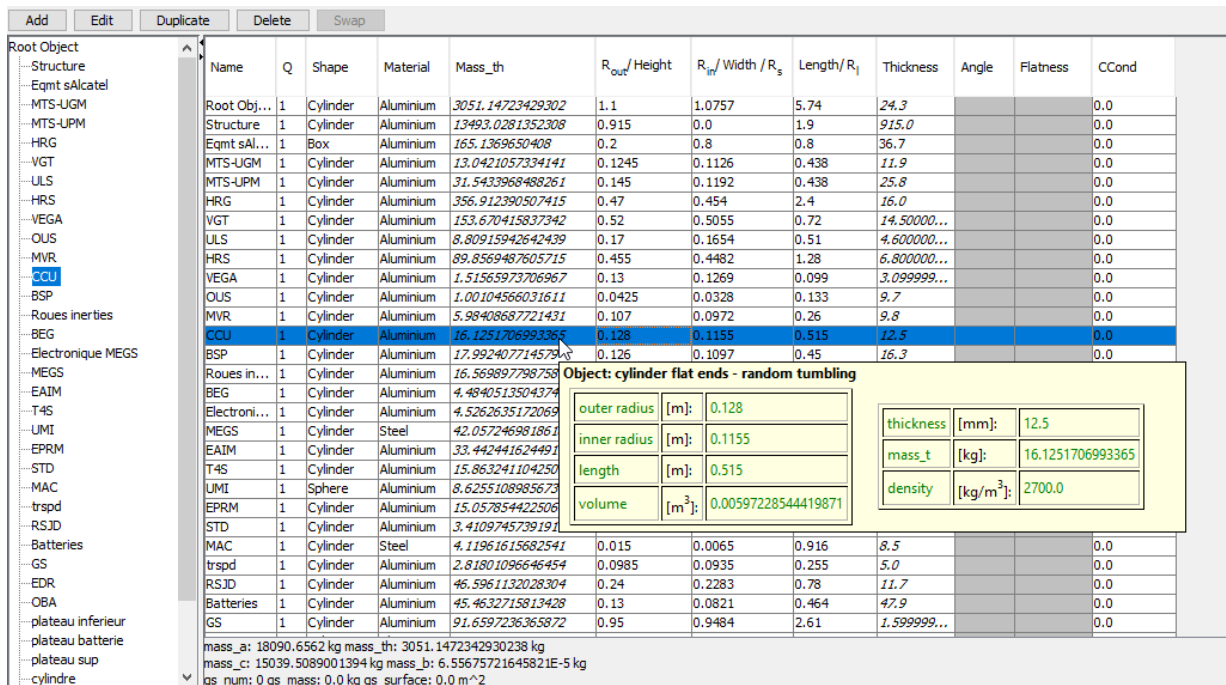
Only the dimensions of the object corresponding to their definition method will be editable. The other dimensions are derived from the first ones are read only and displayed in italics. The Angle and Flatness columns apply only to complex shapes, for simple shapes they will be greyed out.

For example, if a sphere is specified using inner and outer radius, the mass and thickness cells will be read only and displayed in italics.

T4S	1	Cylinder	Aluminium	<i>15.8632411042505</i>	0.126	0.1104	0.404	<i>15.6</i>			0.0
UMI	1	Sphere	Aluminium	<i>8.6255108985673</i>	0.138	0.1231	<i>0.0</i>	<i>14.9</i>			0.0
EPRM	1	Cylinder	Aluminium	<i>15.0578544225061</i>	0.125	0.1089	0.37	<i>16.1</i>			0.0

Figure 27 Display of read only dimensions

If you run your mouse above a line in the table, you will see information on the object as in Figure 28. This information includes in particular the physical parameters used to create the object. If one of the values is in red, this means that the value of this parameter is not consistent with the other chosen values.



The screenshot shows a CAD software interface with a table of object properties. The table has columns for Name, Q, Shape, Material, Mass\_th, R<sub>out</sub>/Height, R<sub>in</sub>/Width / R<sub>s</sub>, Length/R<sub>l</sub>, Thickness, Angle, Flatness, and CCond. The row for 'CCU' is highlighted in blue. A pop-up information table is displayed over the 'CCU' row, showing the following parameters:

outer radius [m]:		0.128
inner radius [m]:		0.1155
length [m]:		0.515
volume [m <sup>3</sup> ]:		0.00597228544419871
thickness [mm]:	12.5	
mass_t [kg]:	16.1251706993365	
density [kg/m <sup>3</sup> ]:	2700.0	

The pop-up also includes the text: "Object: cylinder flat ends - random tumbling".

Figure 28 Information table

## Edition of objects

If you click on the “Edit” button, a new window will display as in Figure 29.

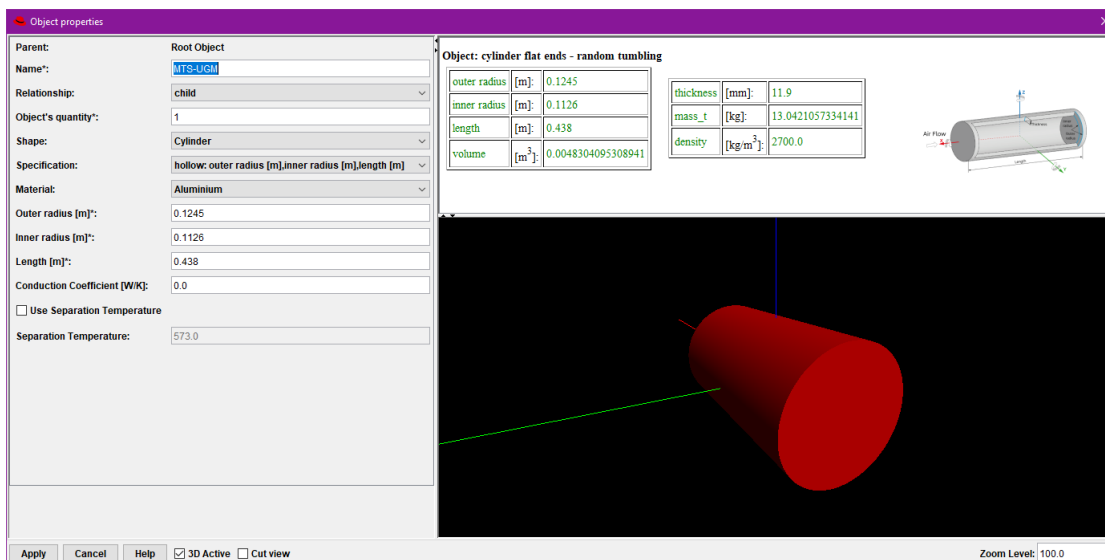


Figure 29 Object edit interface.

This window is identical to the one used to create an object. In this particular case, it is pre-filled with the data for the object selected. You will find in it the parameters visible in the previous table.

In the upper part of the window (Figure 29) you can see an image representing the shape of the object selected and its attitude. In the right part, you will find a table summarising the parameters used for the creation of the object. If one of the parameters is not consistent with the others, it will be in red.

You must click on the “Apply” button for the changes made to be taken into account.

The user can also change the values of the characteristics of each object directly by double-click on the cell of the object table to be modified. Once the operator clicks outside the selected cell, the validity checks are triggered and if the definition of the object is no longer coherent, it is displayed in red (and the “Run” button is disabled), as shown below:

Name	Q	Shape	Material	Mass_th	R <sub>out</sub> /Height	R <sub>in</sub> /Width / R <sub>s</sub>	Length/R <sub>l</sub>	Thickness	Angle	Flatness	CCond
Root Object	1	Cylinder	Aluminium	3051.14723429302	1.1	1.0757	5.74	24.3			0.0
Structure	1	Cylinder	Aluminium	13493.0281352308	0.915	0.0	1.9	915.0			0.0
Eqmt sAlcatel	1	Box	Aluminium	-128.6767757592	0.2	0.8	-0.8	36.7			0.0
MTS-UGM	1	Cylinder	Aluminium	13.0421057334141	0.1245	0.1126	0.438	11.9			0.0
MTS-UPM	1	Cylinder	Aluminium	31.5433968488261	0.145	0.1192	0.438	25.8			0.0
HRG	1	Cylinder	Aluminium	356.912390507415	0.47	0.454	2.4	16.0			0.0
VGT	1	Cylinder	Aluminium	153.670415837342	0.52	0.5055	0.72	14.50000...			0.0
ULS	1	Cylinder	Aluminium	8.80915942642439	0.17	0.1654	0.51	4.600000...			0.0
HRS	1	Cylinder	Aluminium	89.8569487605715	0.455	0.4482	1.28	6.800000...			0.0
VEGA	1	Cylinder	Aluminium	1.51565973706967	0.13	0.1269	0.099	3.099999...			0.0
OUS	1	Cylinder	Aluminium	1.00104566031611	0.0425	0.0328	0.133	9.7			0.0
MVR	1	Cylinder	Aluminium	5.98408687721431	0.107	0.0972	0.26	9.8			0.0
CCU	1	Cylinder	Aluminium	16.1251706993365	0.128	0.1155	0.515	12.5			0.0
BSP	1	Cylinder	Aluminium	17.992407714579	0.126	0.1097	0.45	16.3			0.0
Roues inerties	1	Cylinder	Aluminium	16.5698977987589	0.178	0.1574	0.135	20.6			0.0
BEG	1	Cylinder	Aluminium	4.4840513504374	0.091	0.0825	0.28	8.499999...			0.0
Electronique MEGS	1	Cylinder	Aluminium	4.52626351720699	0.125	0.1195	0.28	5.500000...			0.0
MEGS	1	Cylinder	Steel	42.0572469818618	0.1025	0.085	0.446	17.5			0.0
EAIM	1	Cylinder	Aluminium	33.4424416244917	0.1575	0.1368	0.52	20.7			0.0
T4S	1	Cylinder	Aluminium	15.8632411042505	0.126	0.1104	0.404	15.6			0.0
UMI	1	Sphere	Aluminium	8.6255108985673	0.138	0.1231	0.0	14.9			0.0
EPRM	1	Cylinder	Aluminium	15.0578544225061	0.125	0.1089	0.37	16.1			0.0
STD	1	Cylinder	Aluminium	3.41097457391911	0.1035	0.0994	0.386	4.099999...			0.0
MAC	1	Cylinder	Steel	4.11961615682541	0.015	0.0065	0.916	8.5			0.0
frspd	1	Cylinder	Aluminium	2.81801096646454	0.0985	0.0935	0.255	5.0			0.0
RSJD	1	Cylinder	Aluminium	46.5961132028304	0.24	0.2283	0.78	11.7			0.0
Batteries	1	Cylinder	Aluminium	45.4632715813428	0.13	0.0821	0.464	47.9			0.0
GS	1	Cylinder	Aluminium	91.6597236365872	0.95	0.9484	2.61	1.599999...			0.0

mass\_a: 18090.6562 kg mass\_th: 3051.1472342930238 kg  
mass\_c: 14745.6951593394 kg mass\_b: 293.813806367572 kg  
gs\_num: 0 gs\_mass: 0.0 kg gs\_surface: 0.0 m^2

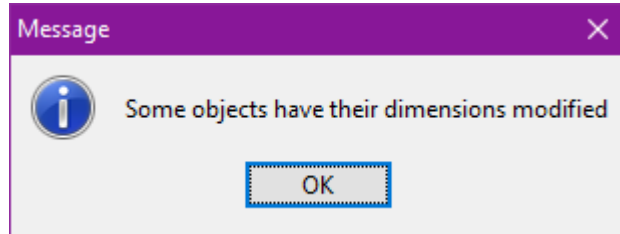
Figure 30 Editing an object directly in the table

Name	Q	Shape	Material	Mass_th	R <sub>out</sub> /Height	R <sub>in</sub> /Width / R <sub>s</sub>	Length/R <sub>l</sub>	Thickness	Angle	Flatness	CCond
Root Object	1	Cylinder	Aluminium	3051.14723429302	1.1	1.0757	5.74	24.3			0.0
Structure	1	Cylinder	Aluminium	13493.0281352308	0.915	0.0	1.9	915.0			0.0
Eqmt sAlcatel	1	Box	Aluminium	-128.6767757592	0.2	0.8	-0.8	36.7			0.0
MTS-UGM	1	Cylinder	Aluminium	13.0421057334141	0.1245	0.1126	0.438	11.9			0.0
MTS-UPM	1	Cylinder	Aluminium	31.5433968488261	0.145	0.1192	0.438	25.8			0.0
HRG	1	Cylinder	Aluminium	356.912390507415	0.47	0.454	2.4	16.0			0.0
VGT	1	Cylinder	Aluminium	153.670415837342	0.52	0.5055	0.72	14.50000...			0.0
ULS	1	Cylinder	Aluminium	8.80915942642439	0.17	0.1654	0.51	4.600000...			0.0
HRS	1	Cylinder	Aluminium	89.8569487605715	0.455	0.4482	1.28	6.800000...			0.0
VEGA	1	Cylinder	Aluminium	1.51565973706967	0.13	0.1269	0.099	3.099999...			0.0
OUS	1	Cylinder	Aluminium	1.00104566031611	0.0425	0.0328	0.133	9.7			0.0
MVR	1	Cylinder	Aluminium	5.98408687721431	0.107	0.0972	0.26	9.8			0.0
CCU	1	Cylinder	Aluminium	16.1251706993365	0.128	0.1155	0.515	12.5			0.0
BSP	1	Cylinder	Aluminium	17.992407714579	0.126	0.1097	0.45	16.3			0.0
Roues inerties	1	Cylinder	Aluminium	16.5698977987589	0.178	0.1574	0.135	20.6			0.0
BEG	1	Cylinder	Aluminium	4.4840513504374	0.091	0.0825	0.28	8.499999...			0.0
Electronique MEGS	1	Cylinder	Aluminium	4.52626351720699	0.125	0.1195	0.28	5.500000...			0.0
MEGS	1	Cylinder	Steel	42.0572469818618	0.1025	0.085	0.446	17.5			0.0
EAIM	1	Cylinder	Aluminium	33.4424416244917	0.1575	0.1368	0.52	20.7			0.0
T4S	1	Cylinder	Aluminium	15.8632411042505	0.126	0.1104	0.404	15.6			0.0
UMI	1	Sphere	Aluminium	8.6255108985673	0.138	0.1231	0.0	14.9			0.0
EPRM	1	Cylinder	Aluminium	15.0578544225061	0.125	0.1089	0.37	16.1			0.0
STD	1	Cylinder	Aluminium	3.41097457391911	0.1035	0.0994	0.386	4.099999...			0.0
MAC	1	Cylinder	Steel	4.11961615682541	0.015	0.0065	0.916	8.5			0.0
frspd	1	Cylinder	Aluminium	2.81801096646454	0.0985	0.0935	0.255	5.0			0.0
RSJD	1	Cylinder	Aluminium	46.5961132028304	0.24	0.2283	0.78	11.7			0.0
Batteries	1	Cylinder	Aluminium	45.4632715813428	0.13	0.0821	0.464	47.9			0.0
GS	1	Cylinder	Aluminium	91.6597236365872	0.95	0.9484	2.61	1.599999...			0.0

mass\_a: 18090.6562 kg mass\_th: 3051.1472342930238 kg  
mass\_c: 14745.6951593394 kg mass\_b: 293.813806367572 kg  
gs\_num: 0 gs\_mass: 0.0 kg gs\_surface: 0.0 m^2

Figure 31 Wrong value while editing an object directly in the table

During the configuration loading, the program might modify automatically the characteristics of an object by rounding some values to remove some extra significant digits. A dialog window is opened to inform the user of the modification and the object line will be marked in blue.



**Figure 32: Dialog to inform the user about the automatic modification of the object properties.**

The automatically modified object will be kept in blue, until the configuration is saved or until another property of the object is modified, in this case we consider that the automatically modified value has been assessed.

<input type="button" value="Add"/> <input type="button" value="Edit"/> <input type="button" value="Duplicate"/> <input type="button" value="Delete"/> <input type="button" value="Swap"/>													
Name	Q	Shape	Material	Mass_th	R <sub>out</sub> / Height	R <sub>in</sub> / Width / R <sub>s</sub>	Length/ R <sub>l</sub>	Thickness	Angle	Flatness	CCond	xCd	+Cd
Root Obj...	1	Cylinder	Aluminium	3051.14223...	1.1	1.0757	5.74	24.3			0.0	1.0	0.0
Structure	1	Cylinder	Aluminium	13513.0842...	0.91567977...	0.0	1.9	915.6797...			0.0	1.0	0.0
Eqmt sAl...	1	Box	Aluminium	345.0	0.2	0.8	0.8	99.69199...			0.0	1.0	0.0
MTS-UGM	1	Cylinder	Aluminium	13.0421057...	0.1245	0.1126	0.438	11.9			0.0	1.0	0.0
MTS-UPM	1	Cylinder	Aluminium	37.5433966...	0.145	0.1192	0.438	25.8			0.0	1.0	0.0

**Figure 33: Automatically modified object in input panel.**

<input type="button" value="Add"/> <input type="button" value="Edit"/> <input type="button" value="Duplicate"/> <input type="button" value="Delete"/> <input type="button" value="Swap"/>														
Name	Q	Demise altitude	Impact energy	ΣCasualty area	ΣWeighted CA	Cross section area	End mass_a	Ini mass_a	%Mass_a left	Max T	End T	End CCond	xCd	+Cd
Root Obj...	1	NC	NC	0.0	0.0	11.819	0.0	18090.6562	0.0	300.0	300.0	0.0	1.0	0.0
Structure	1	100.0	5.43935...	6.825	6.825	4.05	13513.0842	13513.0842	100.0	529.9	529.9	0.0	1.0	0.0
Eqmt sAl...	1	89.99	1324687...	1.647	1.647	0.467	280.8491	345.0	81.41	850.0	846.5	0.0	1.0	0.0
MTS-UGM	1	71258.63	0.0	0.0	0.0	0.093	0.0	13.0421	0.0	850.0	850.0	0.0	1.0	0.0
MTS-UPM	1	84801.9	0.0	0.0	0.0	0.095	0.0	31.5434	0.0	850.0	850.0	0.0	1.0	0.0
HRG	1	100.0	27394.891	4.104	4.104	2.033	68.4519	356.9124	19.18	850.0	690.2	0.0	1.0	0.0

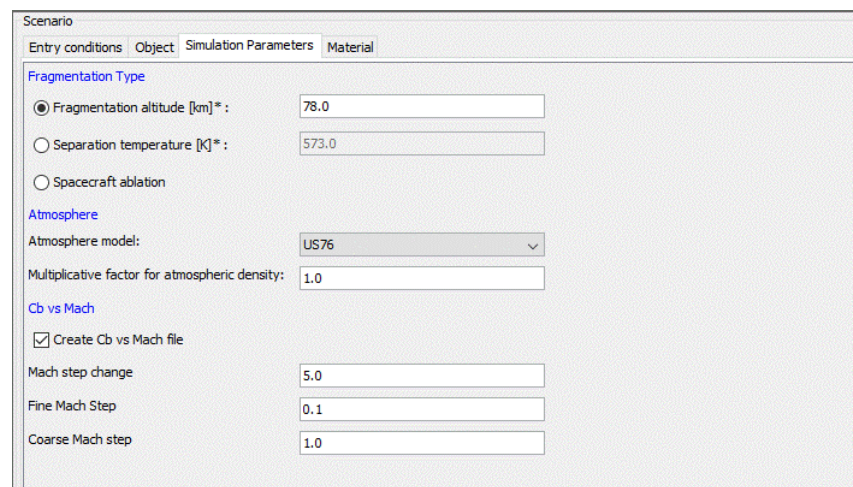
**Figure 34: Automatically modified object in result panel.**

	<p>CNES</p> <p>DEBRISK</p>		Ref.	DBK-MU-LOG-0268-THA	
			Date	13/11/2025	
			Version	2.23	Page: 58/120

#### 7.5.1.4 Simulation Parameters tab

In the Simulation Parameters tab, you will find the options to select:



- The fragmentation method for the satellite.
- The atmosphere model.
- The options for the creation of the Cb/Mach files.



**Figure 35: Simulations Parameters tab**

The visibility of some of the input fields depend on the value of other fields:

- When “Atmosphere model” is “MSIS2000” the solar and magnetic activity fields are displayed.

	CNES  DEBRISK		Ref.	DBK-MU-LOG-0268-THA	
			Date	13/11/2025	
			Version	2.23	Page: 59/120

### 7.5.1.5 Materials tab

Each simulation has its own Materials tab, so the modification of the properties of a material of one simulation does not impact the corresponding material of another simulation.

In the Materials tab, you will find the properties of the various materials used in the simulation. This includes the following parameters for each material:

- density in kg/m<sup>3</sup>
- heat of fusion in J/kg
- melting temperature in K
- oxidation heat in J/kg (O<sub>2</sub>)

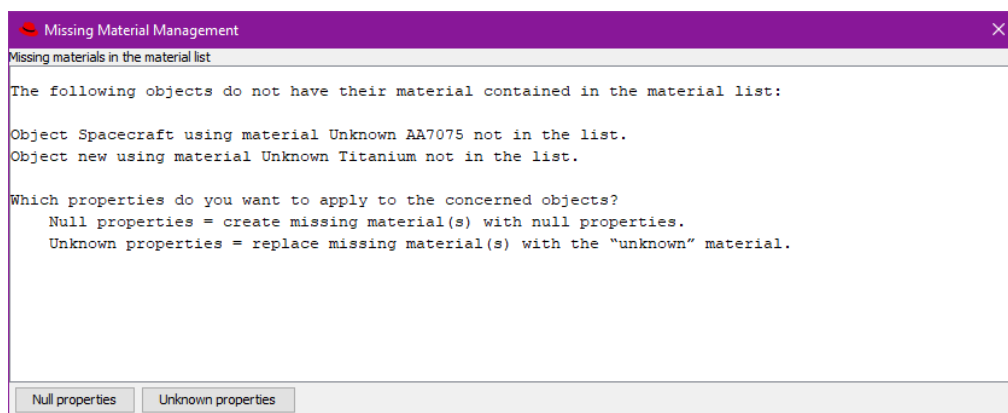
There is also a graph summarising the thermal properties of the material, in which you will find a line corresponding to the emissivity and Cp according to the temperature.

Some materials are defined by default. They are displayed in purple and named “xxx DEBRISK”. They cannot be modified. As for the other types of materials, the user can change the values of their characteristics of each material directly by double-click on the cell of the table to be modified.



If one of the materials is not recognized by the software when opening of an XML file, DEBRISK ask the user if the materials shall be created with all their properties set to null or if the objects shall be associated with the “Unknown” material, whose properties are visible but cannot be changed in the material table.

The list of all the unknown materials is displayed in a single pop-up to warn the user:

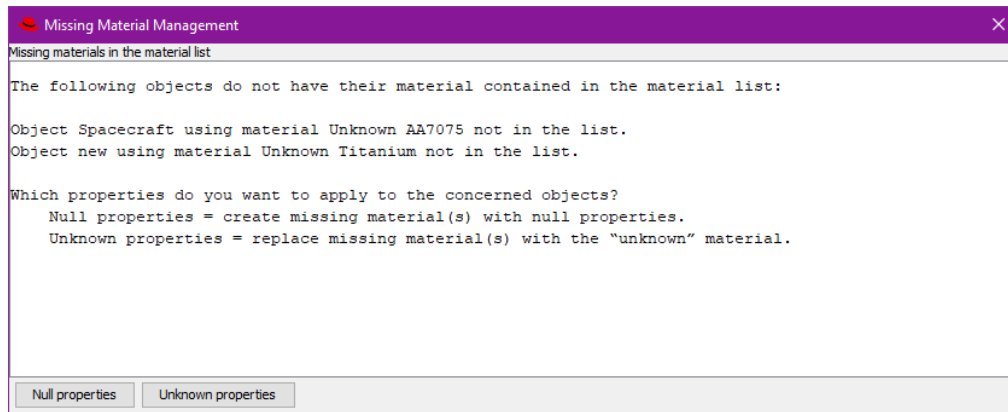


**Figure 36 Unknown materials warning pop-up**

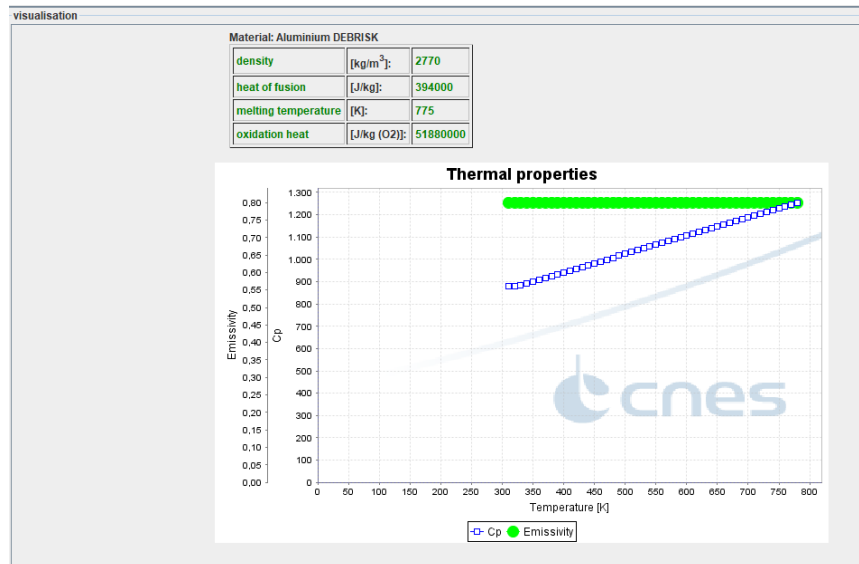
The creation of these materials by the user is explained in section 7.6.1.3.

The panel contains 2 buttons:


- **Load materials:** To load a userMaterials file into the panels. The parameters not contained in the file will be loaded with their default values. If the values of the parameters of default materials are different from the default ones, an error message will appear.
- **Save simulation parameters:** To save the current materials panel contents into an xml file.



**Figure 37 Materials tab Panel**

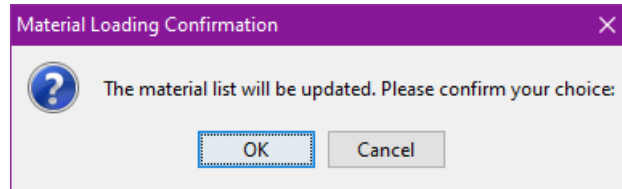


**Figure 38 Materials tab thermal properties graph**

	CNES  DEBRISK		Ref.	DBK-MU-LOG-0268-THA	
			Date	13/11/2025	
			Version	2.23	Page: 61/120

#### 7.5.1.5.1 Loading of a material list

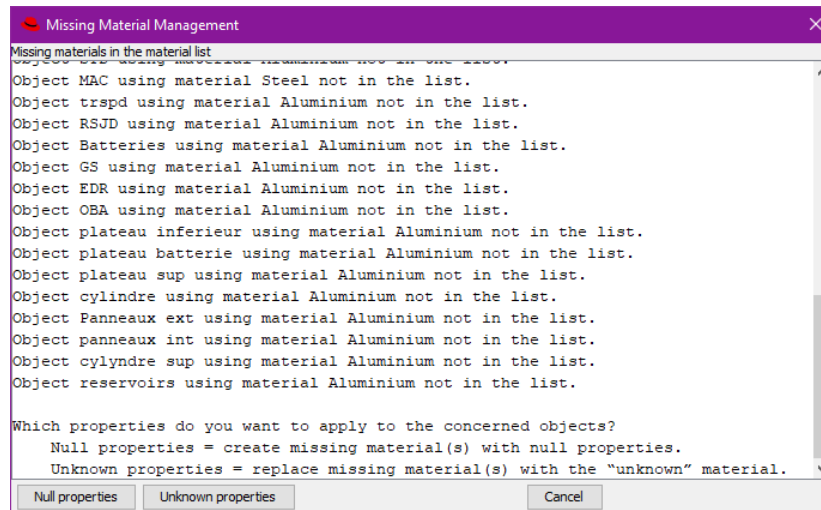
The user can load a material list using the “Load Materials” button and selecting a material list xml file. A confirmation window will be displayed:



**Figure 39 Load materials confirmation dialog**

If the user cancels the current material list will remain unmodified, in other case the new material list will be loaded. The properties of objects related to material properties as the mass and volume will be modified accordingly.

If the new material list does not contain all the materials used by the objects in the simulation, the missing materials will be added to the list. A dialog will be displayed allowing the user to select to add these materials with all their properties set to null or not to add them and use the *Unknown* material instead:



**Figure 40: Selection of missing material properties**

#### 7.5.1.6 Result Panel



After a simulation, in the object tab, a table displays a summary of the state of each object at the end of the simulation.

Scenario												
Entry conditions Object Simulation Parameters Material												
Add Edit Duplicate Delete Swap												
Name	Q	Demise altitude	Impact energy	ΣCasualty area	ΣWeighted CA	Cross section area	End mass_a	Ini mass_a	%Mass_a left	Max T	End T	End CCond
Root Object	1	78000.0	0.0	0.0	0.0	11.819	0.0	18090.6562	0.0	300.0	300.0	0.0
Structure	1	0.0	5.47781142747E3	6.82	6.82	4.046	13493.0281	13493.0281	100.0	451.6	451.6	0.0
Eqmt sAlcatel	1	0.0	356642.835	1.706	1.706	0.499	148.5888	165.137	89.98	850.0	840.0	0.0
MTS-UGM	1	9003.1	0.0	0.0	0.0	0.093	0.0	13.0421	0.0	850.0	275.2	0.0
MTS-UPM	1	0.0	1911.404	0.838	0.838	0.1	3.8025	31.5434	12.05	850.0	714.5	0.0
HRG	1	0.0	290952.575	4.17	4.17	2.08	223.7475	356.9124	62.69	850.0	811.4	0.0
VEGA	1	0.0	65492.017	2.532	2.532	0.982	78.3221	153.6704	50.97	850.0	790.8	0.0
ULS	1	25529.0	0.0	0.0	0.0	0.173	0.0	8.8092	0.0	850.0	190.8	0.0
MVR	1	0.0	5146.42	2.898	2.898	1.215	21.8606	89.8569	24.33	850.0	582.8	0.0
VEGA	1	75552.1	0.0	0.0	0.0	0.044	0.0	1.5157	0.0	850.0	850.0	0.0
OUS	1	73570.42	0.0	0.0	0.0	0.008	0.0	1.001	0.0	850.0	850.0	0.0
MVR	1	32662.89	0.0	0.0	0.0	0.052	0.0	5.9841	0.0	850.0	232.6	0.0
CCU	1	2481.65	0.0	0.0	0.0	0.11	0.0	16.1252	0.0	850.0	274.2	0.0
BSP	1	0.0	48.029	0.815	0.286	0.092	0.5902	17.9924	3.28	850.0	381.0	0.0
Roues inerties	1	0.0	96.527	0.727	0.511	0.064	1.0742	16.5699	6.48	850.0	518.5	0.0
BEG	1	71044.86	0.0	0.0	0.0	0.045	0.0	4.4841	0.0	850.0	850.0	0.0
Electronique M...	1	72695.56	0.0	0.0	0.0	0.073	0.0	4.5263	0.0	850.0	850.0	0.0
MEGS	1	0.0	139419.455	0.786	0.786	0.082	29.9133	42.0572	71.13	1700.0	1356.6	0.0
EAIM	1	0.0	1294.648	0.939	0.939	0.136	3.6977	33.4424	11.06	850.0	658.2	0.0
T4S	1	0.0	30.596	0.793	0.122	0.084	0.4477	15.8632	2.82	850.0	349.8	0.0
UMI	1	18991.86	0.0	0.0	0.0	0.048	0.0	8.6255	0.0	850.0	284.0	0.0
EPRM	1	0.0	29.862	0.77	0.111	0.077	0.4183	15.0579	2.78	850.0	354.7	0.0

Figure 41 Results table

We then find:

- Name: Containing the object name.
- Q: Containing the quantity of fragments. This parameter is used when the operator wants to define several fragments with the exact same characteristics. Even if  $Q > 1$ , a single simulation will be run for the fragment. This value will only be used to compute the aerodynamic mass of an object having children with  $Q=1$  and for the casualty area (which will be computed as the casualty area of the simulated fragment multiplied by  $Q$ ).
- Demise altitude: The object destruction altitude, the cell is coloured in red if the object is not destroyed and in green if it does not reach the ground.
- Impact Energy: The energy of the fragment on impact, the cell is coloured in red if the energy on impact is higher than 14J (or value of maximum energy on impact specified in the expert settings file), in yellow if it is lower or equal, or in green if the object does not reach the ground.
- $\Sigma$  Casualty Area: The casualty area in the case of an object which reaches the ground.
- $\Sigma$  Weighted CA: The weighted casualty area in the case of an object which reaches the ground.
- Cross section area: Average surface.

	CNES  DEBRISK		Ref.	DBK-MU-LOG-0268-THA	
			Date	13/11/2025	
			Version	2.23	Page: 63/120

- End mass\_a: Final aerodynamic mass of the fragment, in case the fragment is destroyed before reaching the ground, otherwise it will be 0.0.
- Ini mass\_a: Initial aerodynamic mass of the fragment.
- %Mass\_a left: Percentage ratio between End mass\_a and Ini mass\_a.
- Max\_T: Maximum temperature reached by the fragment.
- End\_T: Final temperature of the fragment when it is destroyed or reaches the ground.
- End\_CCond: Final value of the conductance coefficient when the object is destroyed or reaches the ground.

Below the table, the total casualty area is displayed:

Total Casualty Area = casualty\_area\_fragment \* quantity \* parent\_quantity \* parent\_parent\_quantity....

Total Weighted Casualty Area = weight\_factor \* total\_casualty\_area

With weight\_factor computed as:

$$\begin{aligned}
 & 0 \quad \text{if} \quad \text{Energy} < \text{min WCA} \\
 & 0.5 - 0.5 \cos \left( \frac{\ln(\text{Energy}) - \ln(\text{min WCA})}{\ln(\text{max WCA}) - \ln(\text{min WCA})} \right) \quad \text{if} \quad \text{min WCA} \leq \text{Energy} \leq \text{max WCA} \\
 & 1 \quad \text{if} \quad \text{Energy} > \text{max WCA}
 \end{aligned}$$

With “min WCA” and “max WCA” the values of the fields “Minimum/Maximum impact energy for weighted casualty area” defined in the “Models section” of the “Simulation Parameters” tab.

	<p>CNES</p> <p>DEBRISK</p>		Ref.	DBK-MU-LOG-0268-THA	
			Date	13/11/2025	
			Version	2.23	Page: 64/120

### 7.5.1.7 Viewing area

The viewing area is in the right part of the interface. It is used to analyse the evolutions of the various parameters during the simulation. The results are presented in five types of predefined graphs that can be selected via a combo-box:

- altitude vs. time
- thermal mass vs. time
- thermal mass vs. altitude
- altitude vs. downrange
- temperature vs. time

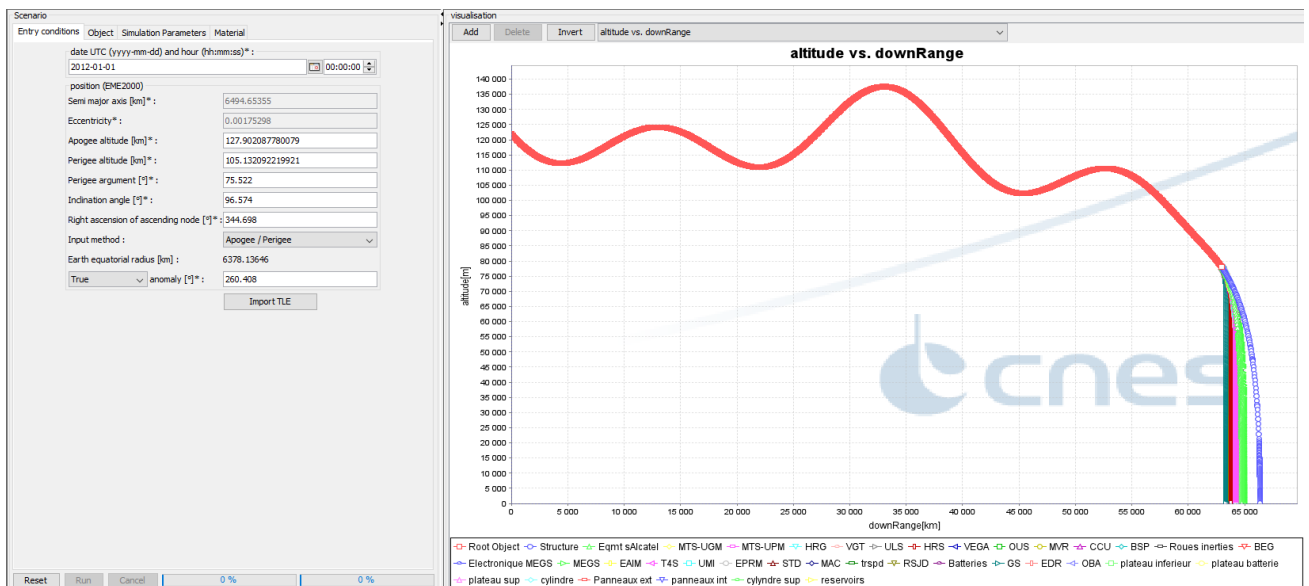
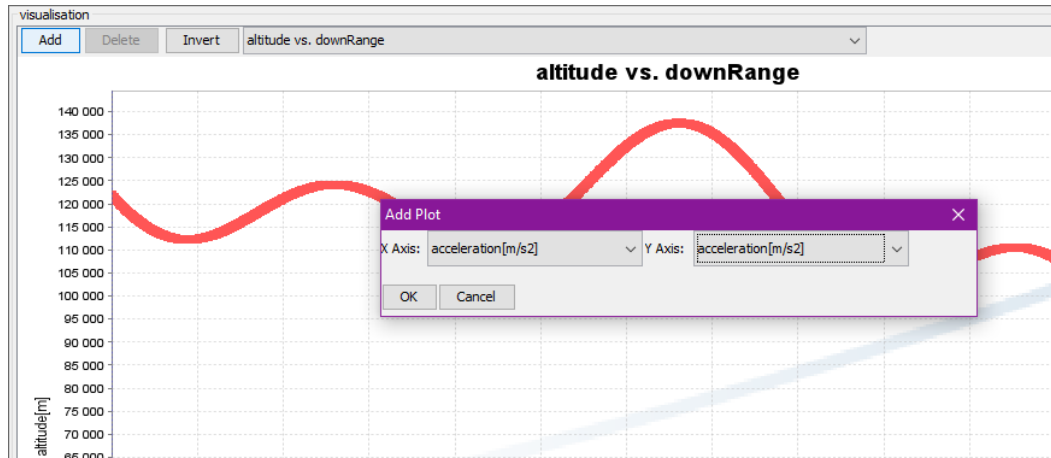


Figure 42 Viewing area on the right

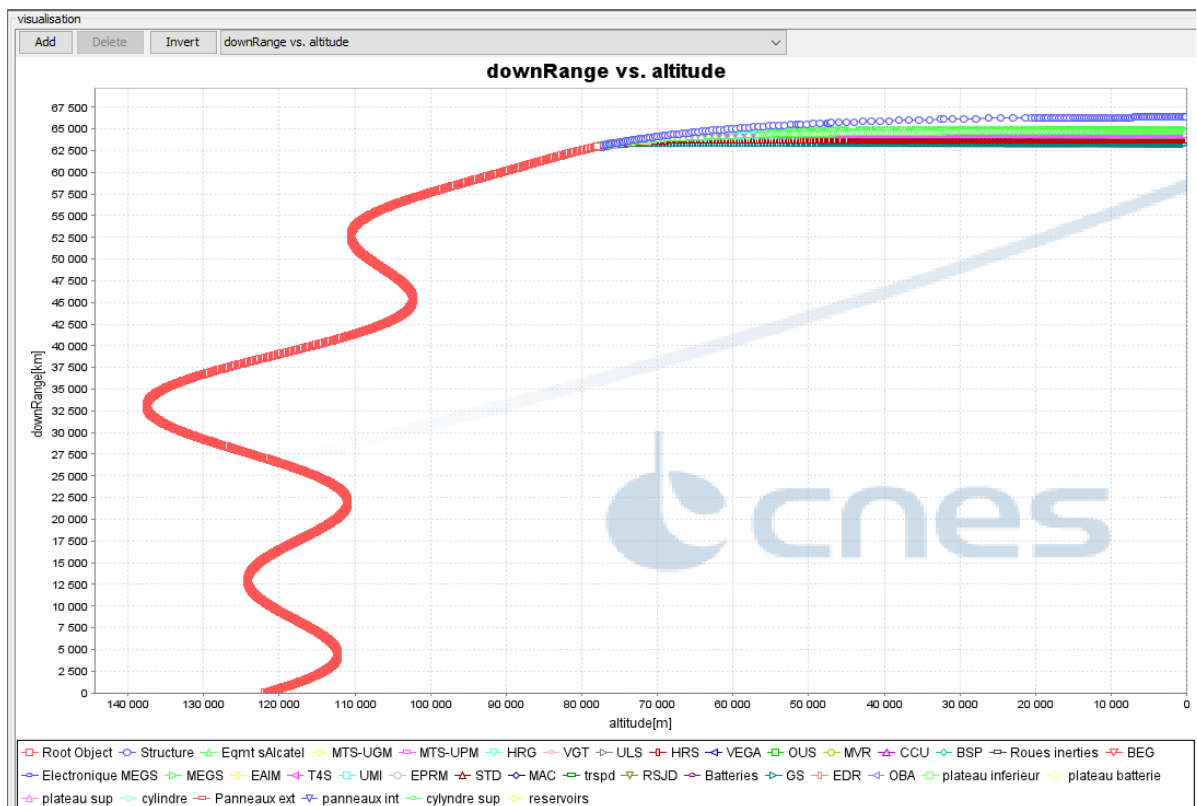
The user is also able to add/delete any other custom graphics to plot one of the available parameters against any other one. To add a new plot, once the button “add” is clicked, a new window appears where the user can choose the parameters to be plotted.




**Figure 43 Creation of custom plot**

To delete any custom graphic, one must only click on the “Delete” button after having selected the plot to be removed (please note that the five plots defined by default cannot be removed).

The user can additionally change the order of the axis of the selected plot by clicking on the “Invert” button:





**Figure 44 Invert plot**

	<p>CNES</p> <p>DEBRISK</p>		Ref.	DBK-MU-LOG-0268-THA	
			Date	13/11/2025	
			Version	2.23	Page: 66/120

When there are too many objects in the simulation, it can be interesting to only view some of them in order to make the analysis easier. To do this, you must select these objects in the table on the left, right-click on one of the objects and click on “Plot selected objects”. Only the objects that have been selected in the table are displayed in the graphic.

To make multiple selections, you can use the “CTRL” and “SHIFT” buttons on your keyboard. The selected lines will be coloured in blue.

	<p>CNES</p> <p>DEBRISK</p>		Ref.	DBK-MU-LOG-0268-THA	
			Date	13/11/2025	
			Version	2.23	Page: 67/120

### Google-Earth view

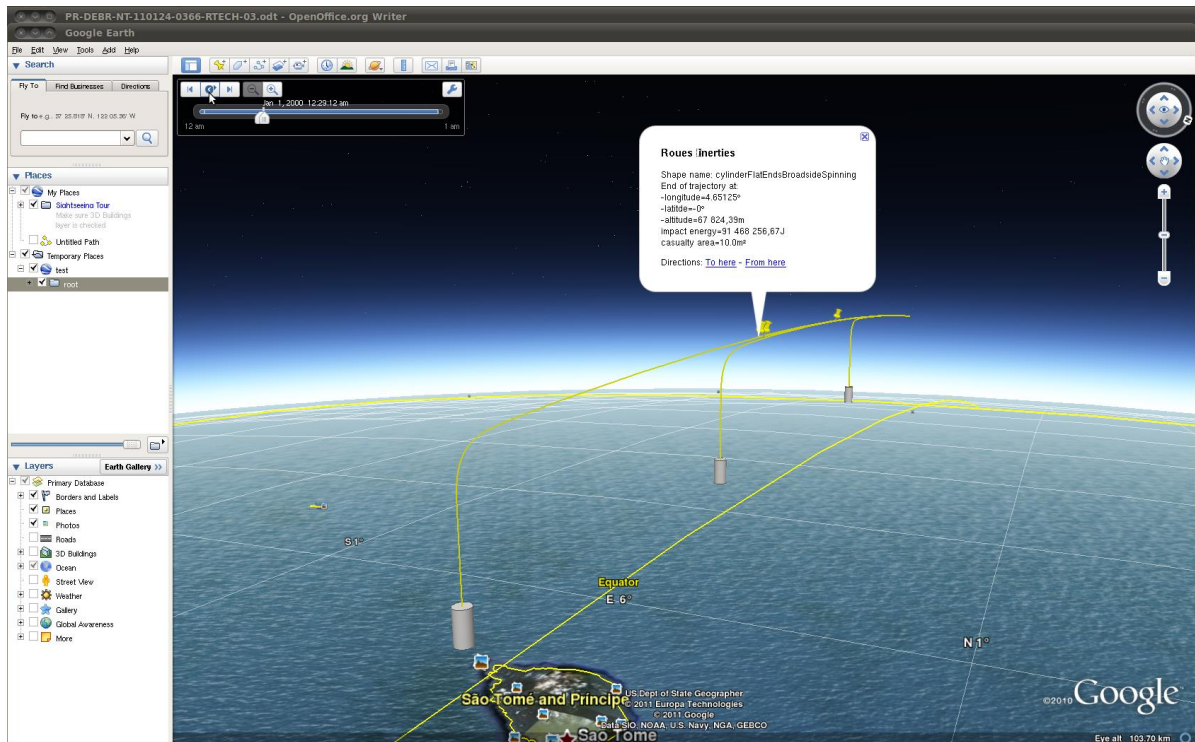
Here-below is an example of simulation viewed in Google Earth.

To be able to view the results in Google Earth, you must save the simulation by clicking on the “Export” button, and then “KML”, select the backup directory, the file name, and click on “save”.


Finally, open Google Earth and open the file you just saved. In the top left-hand part, you can click on the second button to see the trajectory move.

You will then see that when an object is destroyed or reaches the ground, the 3D model of the object turns into a small yellow thumbtack. You can click on it to obtain more information on the end-of-flight of this object, as you can see on Figure 45.

The simulation made can also be saved by clicking on *File* and then on *Save*, and by selecting a backup name. This will save the list of objects, as well as the parameters of the scenario, making it possible to re-launch an identical simulation at a later stage.



**Figure 45 Simulation viewed in Google Earth**

	<p>CNES</p> <p>DEBRISK</p>		Ref.	DBK-MU-LOG-0268-THA	
			Date	13/11/2025	
			Version	2.23	Page: 68/120

### 7.5.1.8 Message zone

The top area of the IHM contains a message zone where all the messages produced during the execution are displayed.

The contents of the message zone can be cleared using the “Clear” button.

The message zone will not be cleared when resetting the simulation or executing it again.

Each simulation has an independent message zone.

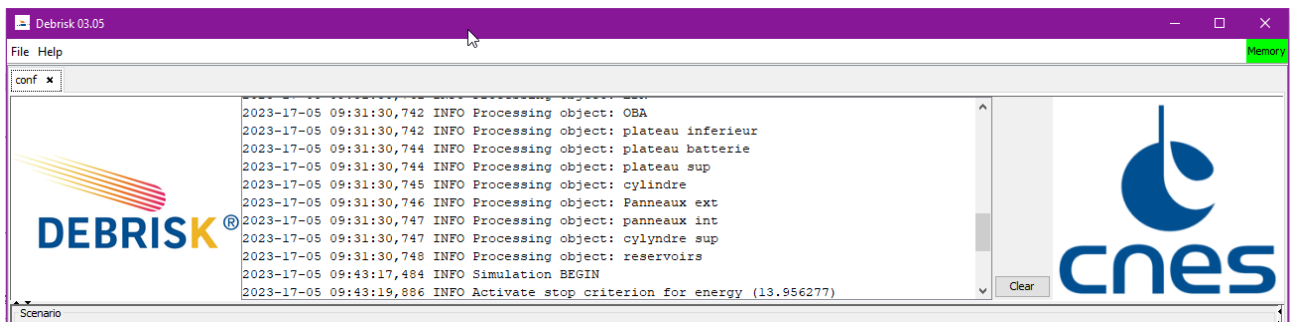


Figure 46: Message area

	CNES  DEBRISK		Ref.	DBK-MU-LOG-0268-THA	
			Date	13/11/2025	
			Version	2.23	Page: 69/120

## 7.6 Materials

### 7.6.1.1 Materials file

An alternative location of the materials file can be specified by the user using the command line option:

```
--userMaterials <materials file path>
```

The option works both in batch mode and in MMI mode.

### 7.6.1.2 Integrated materials

A certain number of materials are created during the installation of Debrisk. You can choose among these materials every time you want to create or edit an object. A drop-down list containing all the materials is available.

Some materials are defined by default. They are displayed in purple, are named “xxx DEBRISK” and cannot be modified or removed.


### 7.6.1.3 Materials created by the user

If you wish to use a specific material not available as yet in DEBRISK, you can create it. To do so, you must click in the “Material” tab in the “Scenario” part, and then on the *Add* button.

When you wish to create a new material, you have two possibilities. Either you create it from scratch (by clicking directly on *Add*), or you derive it from an existing material by selecting a material and clicking on *Duplicate*. Either way, it is not possible to name the new material with a character string containing “Debrisk”. When duplicating a “xxx DEBRISK” material, the oxidation properties are not duplicated, they are set to their default values.

The userMaterials file will not be automatically saved each time the property of a material is changed. The user can save the materials by using the “save materials” button. To create a totally new material, you must enter the following parameters:

- Name: material name
- Density: density of the material (in kg/m<sup>3</sup>)
- Melting Temperature: melting temperature (K)
- Heat Of Fusion: heat of fusion (J/kg)
- Oxide Heat Of Formation: oxidation flux (J/kg (O<sub>2</sub>))
- Emissivity: emissivity

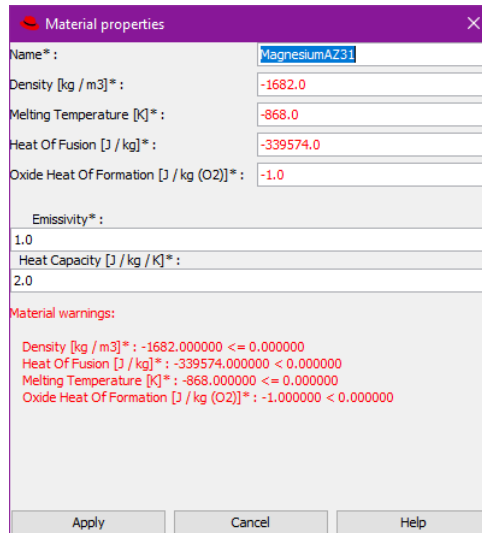
	CNES  DEBRISK		Ref.	DBK-MU-LOG-0268-THA	
			Date	13/11/2025	
			Version	2.23	Page: 70/120

- Heat Capacity: heat capacity (J/kg/°K),

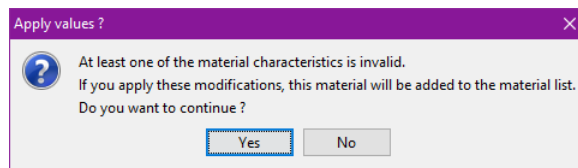
For the first five parameters, you must enter a single value, which will be a character string for the name of the material, and numeric values for the density, the melting temperature, the heat of fusion and the oxide heat of formation. The name of the material created cannot contain the character string “debrisk”.

If the material definition is invalid because some parameters are out of range an warning method will be displayed at the bottom of the window and if the user wants to apply the values a confirmation will be requested.

For the emissivity and the heat capacity, you can enter either a table of values according to the temperature or a polynomial (or a constant) representing this relationship.



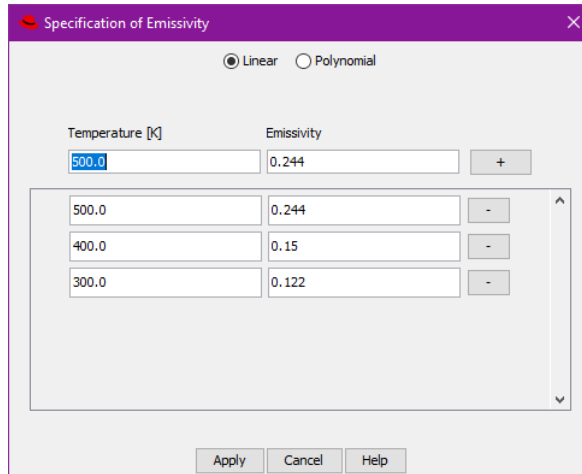
**Figure 47 Adding a customised material.**



**Figure 48: Confirmation dialog for invalid materials.**

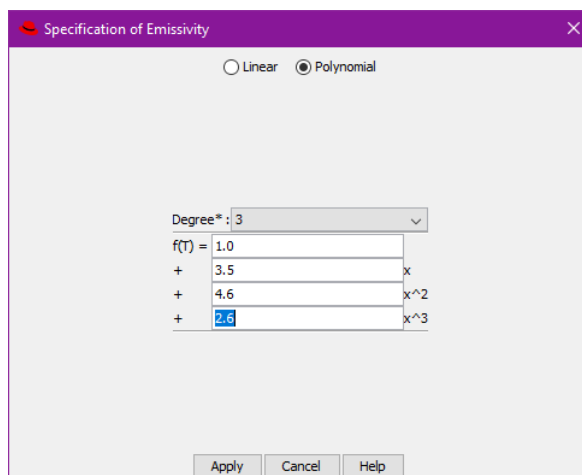
	CNES  DEBRISK		Ref.	DBK-MU-LOG-0268-THA	
			Date	13/11/2025	
			Version	2.23	Page: 71/120

If you wish to enter a table of values, select the “linear Interpolation” type in the window which opens (see Figure 49). The first number in each pair is the temperature, and the second corresponds to the value of the parameter you wish to define, i.e. in our example, the emissivity. In this mode, a straight line is drawn between each pair of value.



**Figure 49 Entry of a linear evaluation**

If you prefer to use the polynomial form, you must specify the degree of the polynomial and provide the coefficients. If you enter only one coefficient, this means that the parameter is constant over the whole temperature range. In the example given above (see Figure 50), k is considered as constant and equal to 110, regardless of the temperature.



**Figure 50 Entry of a polynomial**

In both cases the emissivity and Cp will be evaluated in the temperature range (300K to melting temperature) in steps of 10 degrees to verify that:

- The Cp is positive ( $\geq 0.0$ ) in all the range.
- The emissivity is in the range  $[0,1]$  in all the range.

If this is not the case, an error message will be displayed, and it will not be possible to apply the changes to the material until the problem is corrected.

## 7.7 Shape of objects

The objects available in DEBRISK are described in this section. The objects are defined by their geometrical shape. The attitude of the object depends on its aerodynamic behaviour, on the forces applied on separation, on the position of the centre of gravity of the object, factors which are difficult to predict accurately. The use of external tools could be envisaged to guide the user in the choice to be made for each object. In the current version, all the objects are considered to be in tumbling attitude mode during their re-entry. The tumbling attitude of each object is defined by its shape and defined below in the corresponding section.

To choose the shape of the object, you must click and fill in the *shape* field in the “object properties” window.

Depending on the shape, you can select the set of dimensions to fill out. With these values the software will compute the rest of the dimensions.


The precision for the dimensions used to define a shape is 14 significant digits, the rest of the dimensions will be computed with the machine precision.



The same object defined using different sets of dimensions will produce two similar objects but not identical, so the results of the simulation may differ.

Scenario												
Entry conditions Object Simulation Parameters Material												
Add Edit Duplicate Delete Swap												
	Name	Q	Shape	Material	Mass_th	R <sub>out</sub> /Height	R <sub>in</sub> /Width/ R <sub>l</sub>	Length/R <sub>l</sub>	Thickness	Angle	Flatness	CCond
Spacecraft	Spacecraft	1	Cylinder	Aluminium DEBRISK	17891.7471533123	2.0	1.8	1.0	200.0			
sphere_rout_rin	sphere_rout_rin	1	Sphere	Aluminium DEBRISK	344.619184306438	1.0	0.99	0.0	10.0			
sphere_rout_mass	sphere_rout_mass	1	Sphere	Aluminium DEBRISK	344.619184306438	1.0	0.99	0.0	10.0			
sphere_rout_thickness	sphere_rout_thickness	1	Sphere	Aluminium DEBRISK	344.619184306438	1.0	0.99	0.0	10.0			
sphere_rin_solid	sphere_rin_solid	1	Sphere	Aluminium DEBRISK	344.619184306437	0.309687510288526	0.0	0.0	309.6875...			
sphere_mass_solid	sphere_mass_solid	1	Sphere	Aluminium DEBRISK	344.619184306438	0.309687510288526	0.0	0.0				
sphere_rout_solid	sphere_rout_solid	1	Sphere	Aluminium DEBRISK	344.619184306437	0.309687510288526	0.0	0.0				

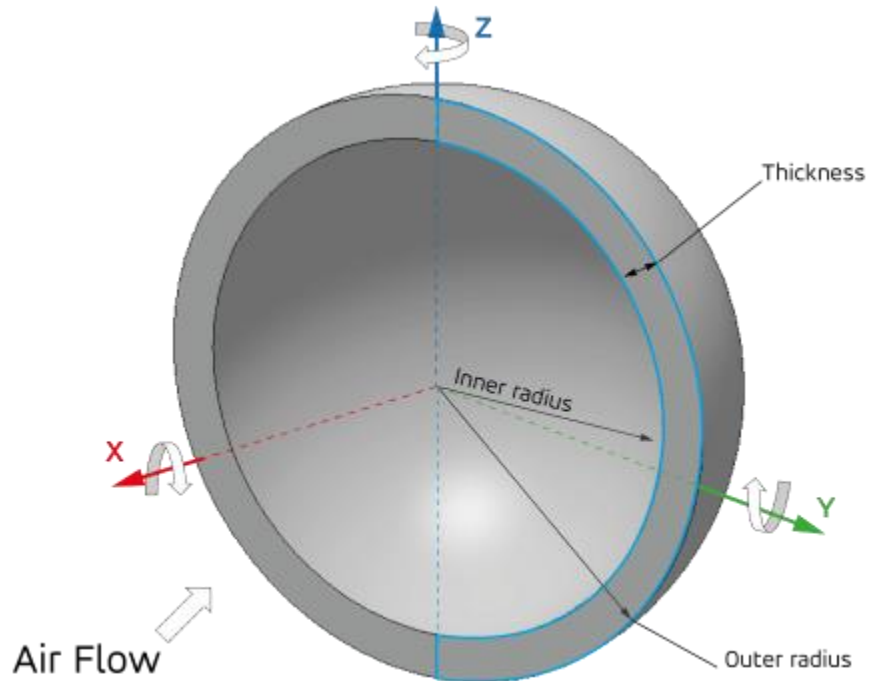
Scenario													
Entry conditions Object Simulation Parameters Material													
Add Edit Duplicate Delete Swap													
	Name	Q	Demise altitude	Impact energy	ICasualty area	IWeighted CA	Cross section area	End mass_a	Ini mass_a	%Mass_a left	Max T	End T	End CCond
Spacecraft	Spacecraft	1	78000.0	0.0	0.0	0.0	9.425	0.0	10000.0	0.0	300.0	300.0	0.0
sphere_rout_rin	sphere_rout_rin	1	0.0	1409950.002	5.608	5.608	3.126	260.2018	344.6192	75.5	775.0	691.4	0.0
sphere_rout_mass	sphere_rout_mass	1	0.0	1409943.41	5.608	5.608	3.126	260.201	344.6192	75.5	775.0	691.4	0.0
sphere_rout_thickness	sphere_rout_thickness	1	0.0	1409950.002	5.608	5.608	3.126	260.2018	344.6192	75.5	775.0	691.4	0.0
sphere_rin_solid	sphere_rin_solid	1	0.0	872401.682	1.32	1.32	0.301	344.6192	344.6192	100.0	725.8	723.6	0.0
sphere_mass_solid	sphere_mass_solid	1	0.0	8724021.541	1.32	1.32	0.301	344.6192	344.6192	100.0	725.8	723.6	0.0
sphere_rout_solid	sphere_rout_solid	1	0.0	8724081.682	1.32	1.32	0.301	344.6192	344.6192	100.0	725.8	723.6	0.0

	CNES		Ref.	DBK-MU-LOG-0268-THA	
	DEBRISK		Date	13/11/2025	
			Version	2.23	Page: 73/120

**Figure 51 Spheres defined using different methods, obtaining different results**

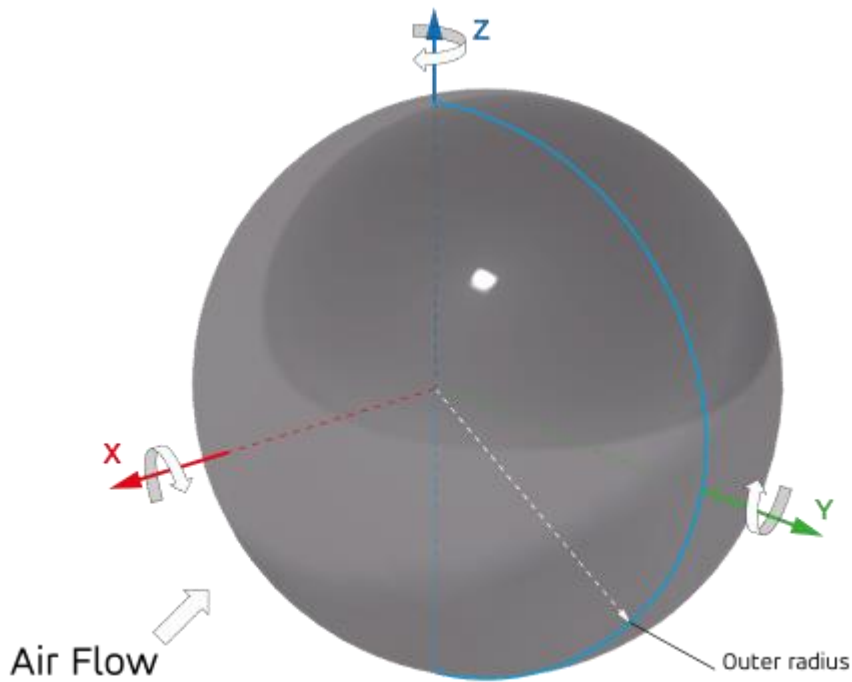
### 7.7.1.1 Sphere

There is only one type of sphere, which is assumed to be in random tumbling mode around the three axes presented in the figure below.



**Figure 52 Hollow sphere random tumbling.**

	CNES  DEBRISK		Ref.	DBK-MU-LOG-0268-THA	
			Date	13/11/2025	
			Version	2.23	Page: 74/120





**Figure 53 Solid sphere random tumbling.**

To create a spherical object, you can enter one of the following sets of parameters according to the selection made in the “specifications” field.

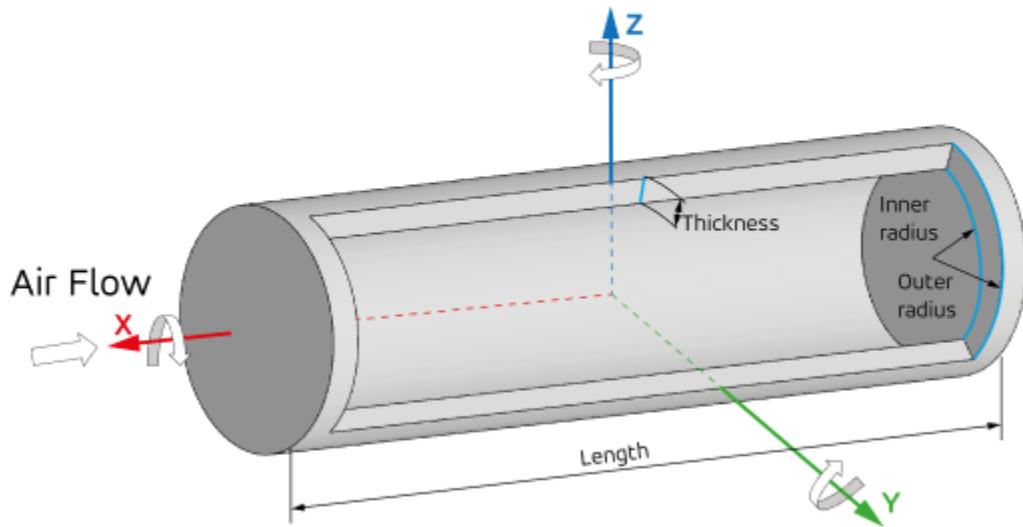
- For the hollow sphere:
  - outer radius and inner radius
  - outer radius and mass
  - outer radius and thickness
  
- For the solid sphere:
  - mass
  - outer radius

The other parameters required for the calculation and not given by the user will be computed by the software. For example, if you choose to enter the outer and inner radii, the software will calculate the corresponding thickness and the mass according to the material selected.

	CNES		Ref.	DBK-MU-LOG-0268-THA	
	DEBRISK		Date	13/11/2025	
			Version	2.23	Page: 75/120

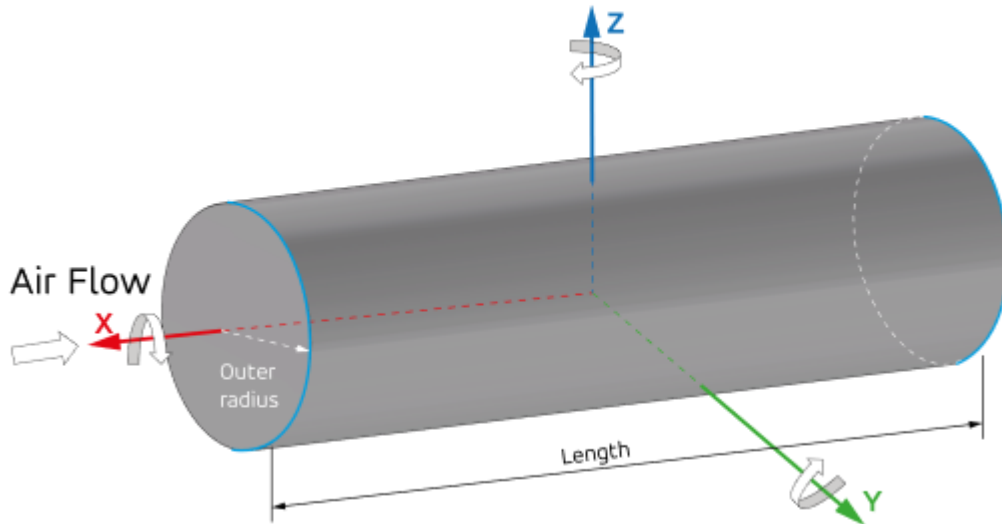
### 7.7.1.2 Cylinder

The cylinder is considered to be in random tumbling mode as defined in Figure 54.



**Figure 54 Hollow cylinder random tumbling**

	CNES  DEBRISK		Ref.	DBK-MU-LOG-0268-THA	
			Date	13/11/2025	
			Version	2.23	Page: 76/120



**Figure 55 Solid cylinder random tumbling**


To create a cylinder, it is necessary to provide one of the sets of information bellow:

- Hollow cylinder:
  - outer radius, inner radius and length
  - outer radius, thickness and length
  - outer radius, length and mass
- Solid cylinder:
  - outer radius and mass

The other parameters required for the calculation are deduced by the software.



The length and inner and outer radii must be between 0 and 100m.

	CNES		Ref.	DBK-MU-LOG-0268-THA	
	DEBRISK		Date	13/11/2025	
			Version	2.23	Page: 77/120

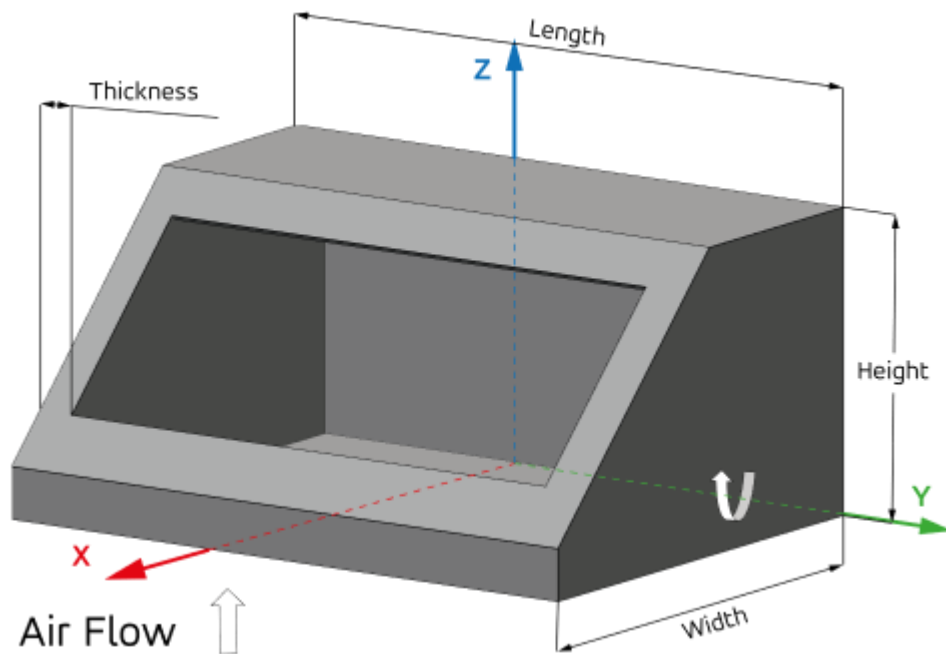
### 7.7.1.3 Box

The box is defined by the user by entering one of two following series of parameters:

- length, width, height, thickness
- length, width, height, mass

For a hollow box, both series can be used. For a solid box, use the < length, width, height, mass > series, having first calculated the mass by the volume x density.

Note: the length must be greater than the width and the width must be greater than the height.



**Figure 56 Box tumbling**

The box is considered to be in random tumbling mode around its longest axis.

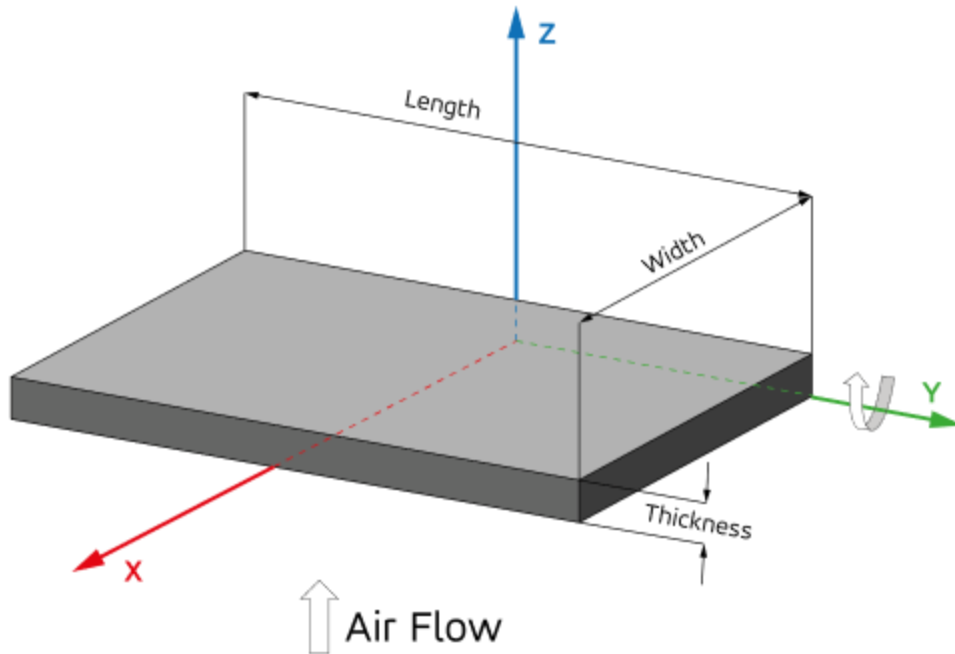
	CNES  DEBRISK		Ref.	DBK-MU-LOG-0268-THA	
			Date	13/11/2025	
			Version	2.23	Page: 78/120

#### 7.7.1.4 Flat plate

The flat plate can be defined by the following parameters:

- length, width, thickness
- length, width, mass

Note: as the box, the length must be greater than the width and the width must be greater than the thickness.



**Figure 57 Flat plate tumbling.**

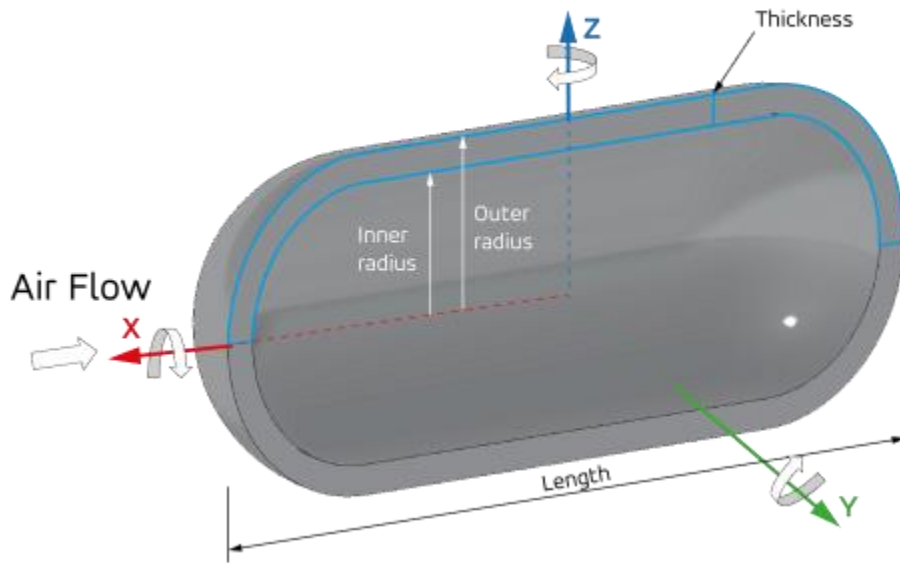
As the box, the flat plate is considered to be in random tumbling mode around its longest axis.

The thickness of the plate must be below 10% of the width. Otherwise, a box object must be used.

	CNES  DEBRISK		Ref.	DBK-MU-LOG-0268-THA	
			Date	13/11/2025	
			Version	2.23	Page: 79/120

### 7.7.1.5 Hemispherical cylinder

The hemispherical cylinder is considered to be in random tumbling mode as defined in Figure 58.

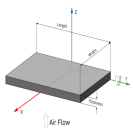


**Figure 58 Hollow hemispherical cylinder random tumbling**

To create a hemispherical cylinder, it is necessary to provide one of the sets of information bellow:

- Hollow hemispherical cylinder:
  - outer radius, inner radius and length
  - outer radius, thickness and length
  - outer radius, length and mass

The other parameters required for the calculation are computed by the software.



The length and inner and outer diameter must be between 0 and 100m.

	CNES  DEBRISK		Ref.	DBK-MU-LOG-0268-THA	
			Date	13/11/2025	
			Version	2.23	Page: 80/120

### 7.7.1.6 Complex shape

The complex shapes are divided in to categories depending on the value of the flatness parameter:

- Conical
- Spherical

Complex shapes are defined by the following parameters:

- large radius, small radius, height, thickness, angle
- large radius, small radius, height, mass, angle

The angle of aperture of complex shapes can be between 0 and 360 degrees, for the range of angle values between (359, 360) the value of 359 will be used.



When defining a complex conical shape, tube equations will be used if all the following conditions are satisfied:

$$R_l = R_s$$

$$angle = 360.0^\circ$$

$$0.1 < \frac{e}{R_l} < 1.0$$

7.7.1.6.1 Complex conical shape

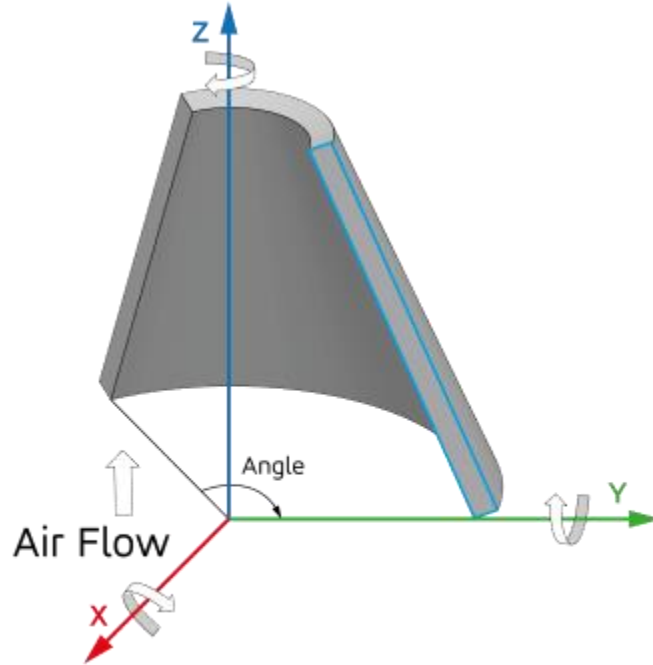


Figure 59 Complex conical shape tumbling.

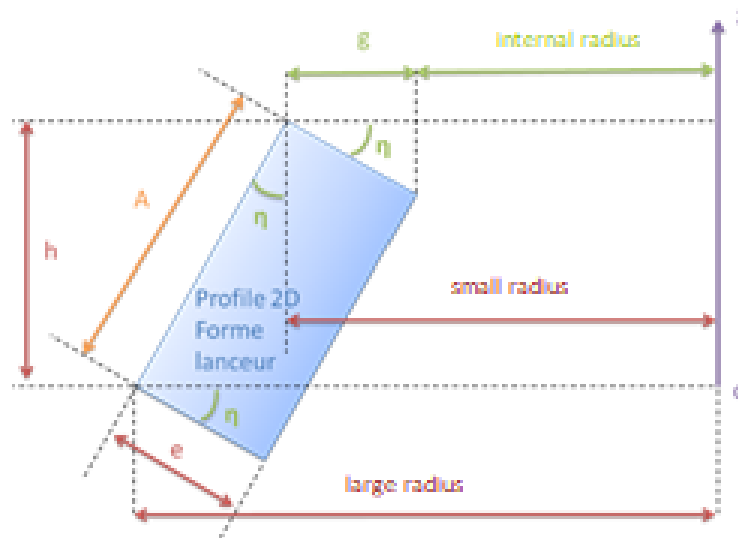



Figure 60 Complex conical shape profile.

The apothem of the conical shape is computed as follows:

	CNES  DEBRISK		Ref.	DBK-MU-LOG-0268-THA	
			Date	13/11/2025	
			Version	2.23	Page: 82/120

$$A = \sqrt{h^2 + \left(\frac{D_G - D_P}{2}\right)^2}$$

The angle  $\eta$  is defined as follows:

$$\cos \eta = \frac{h}{A}$$

The following constraints shall be respected by the shape to be considered valid:

$$R_l \geq R_s$$

$$R_l > e \cos \eta$$

$$h > 0$$

$$0 < e \leq \frac{A}{10}$$

When the following conditions are fulfilled:

$$R_l == R_s$$

$$1.0 > \frac{e}{A} > 0.1$$

the conical shape is modelled as a tube.

When

$$\frac{e}{A} \geq 1.0$$

an error is raised indicating the user that a cylinder shall be used to model the shape.

7.7.1.6.2 Complex spherical shape

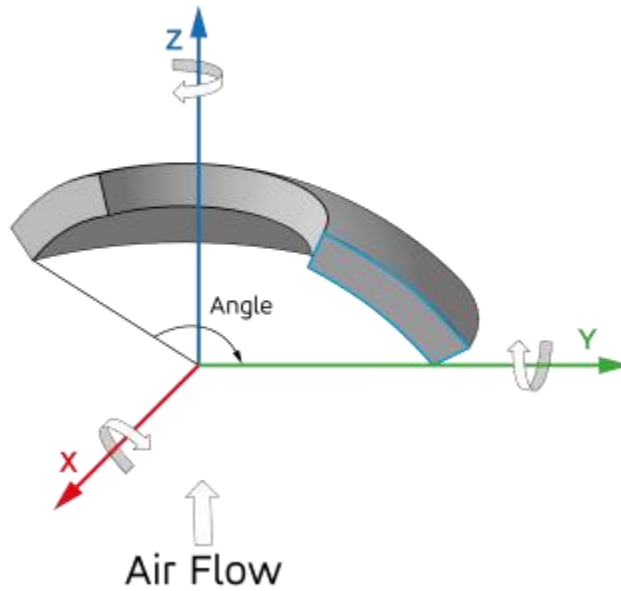
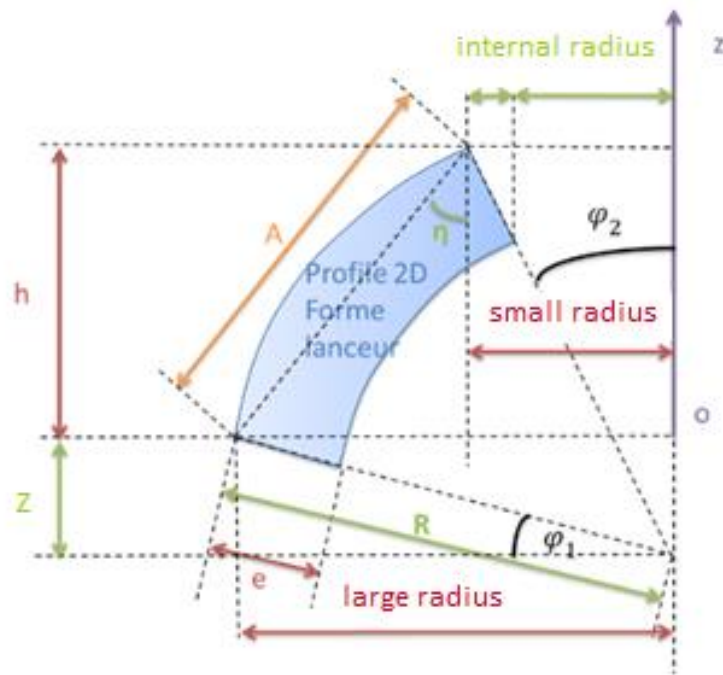



Figure 61 Complex spherical shape tumbling.



	CNES  DEBRISK		Ref.	DBK-MU-LOG-0268-THA	
			Date	13/11/2025	
			Version	2.23	Page: 84/120

**Figure 62 Complex spherical shape profile.**

The apothem of the conical shape is computed as follows:

$$A = \sqrt{h^2 + \left(\frac{D_G - D_P}{2}\right)^2}$$

The following constraints shall be respected by the shape to be considered valid:

$$R_s \geq 0$$

$$R_l \geq R_s$$

$$h > 0$$

$$h \leq \frac{1}{2} \sqrt{(D_g)^2 - (D_p)^2}$$

$$0 < e \leq \frac{A}{10}$$

	CNES  DEBRISK		Ref.	DBK-MU-LOG-0268-THA	
			Date	13/11/2025	
			Version	2.23	Page: 85/120

## 7.8 Heat flow

The absorbed radiation heat flow is assumed null at any altitude.

## 7.9 Oxidation flows

The heat and mass flow produced by the oxidation depends on the model used:

### OxyV3

- $\vartheta_O$  : stoichiometric coefficient of the oxygen in the formed oxide
- $\vartheta_M$  : stoichiometric coefficient of the metal alloy in the formed
- $M_O$  : molar mass of the oxygen [kg mol<sup>-1</sup>]
- $M_M$  : molar mass of the metal alloy formed in the oxide [kg mol<sup>-1</sup>]
- $x_M$  : mass fraction of metal formed in the oxide
- $\Delta_f H^0$  : molar standard formation enthalpy (<0) [J mol<sup>-1</sup>]
- $M_{MOx}$  : molar mass of the oxide [kg mol<sup>-1</sup>]
- $\rho_0$  : mass density of the alloy oxide [kg m<sup>-3</sup>]
- $x_0$  : thickness of the oxide layer [m]

$$\dot{q}_{ox} = - \frac{1 + \frac{\vartheta_O M_O}{\vartheta_M M_M}}{1 + x_M \frac{\vartheta_O M_O}{\vartheta_M M_M}} \frac{\Delta_f H^0}{M_{MOx}} x_M \rho_0 \frac{dx_0}{dt} = k_{ox} \frac{dx_0}{dt}$$

With

$$\frac{dx_0}{dt} = \frac{k'(T)}{x_0}$$

For adherent materials

$$\frac{dx_0}{dt} = k'(T) \quad \text{For non-adherent materials}$$

And

$$k'(T) = A_w e^{-\frac{E_a}{k_B T}}$$

With  $A_w(T)$  et  $\frac{E_a}{k_B}(T)$  defined by the parameters  $A_w$  and  $E_a_{kB}$  of the material in the configuration file.

	CNES  DEBRISK		Ref.	DBK-MU-LOG-0268-THA	
			Date	13/11/2025	
			Version	2.23	Page: 86/120

The mass flow or ablation produced for non-adherent materials only is:

$$\dot{m}_{ob} = - \frac{1}{1 + \frac{\eta_O}{\eta_M} x_M \frac{M_O}{M_M}} \rho_0 \frac{dx_0}{dt} S_{exposed} = k_{oxMassFlowRate} \frac{dx_0}{dt} S_{exposed}$$

## 7.10 Survivability parameter

The survivability parameter is computed as follows:

$$\langle survivabilityParameter \rangle = \frac{\langle demiseAltitude \rangle}{\langle creationAltitude \rangle} - \frac{\langle finalThermalMass \rangle}{\langle initialThermalMass \rangle}$$

## 7.11 Global results

Result computed globally – i.e. per DEBRISK simulation – are stored in the xml in the <globalResult> tree. Those values are not meant to be accessed through the IHM.

### 7.11.1 Total casualty area

The total casualty area  $CA_{total}$  for a DEBRISK simulation is the sum, over all N objects reaching the ground, of the individual casualty area  $CA_{frag}^{(i)}$  of each object, multiplied by its quantity or multiplicity  $q_i$ :

$$CA_{total} = \sum_{i=1}^N q_i * CA_{frag}^{(i)}$$

If the primary fragmentation is controlled by the total ablation of the parent vehicle and the conditions for complete ablation are not met, the total casualty area is the casualty area of the intact (not ablated) or partially ablated parent vehicle  $CA_{S/C}$ :

$$CA_{total}(no\ vehicule\ primary\ fragmentation) = CA_{S/C}$$

Note: Unreleased (or unborn) fragments do not contribute to the casualty area.

### 7.11.2 Total impact mass

The total impact mass  $IM_{total}$  is the sum, over all N objects reaching the ground, of the final aerodynamic mass  $IM_{frag}^{(i)}$  of each object, multiplied by its quantity or multiplicity  $q_i$ :

	CNES  DEBRISK		Ref.	DBK-MU-LOG-0268-THA	
			Date	13/11/2025	
			Version	2.23	Page: 87/120

$$IM_{total} = \sum_{i=1}^N q_i * IM_{frag}^{(i)}$$

If the primary fragmentation is controlled by the total ablation of the parent vehicle and the conditions for complete ablation are not met, the total impact mass corresponds to the aerodynamic mass of the intact (not ablated) or partially ablated parent vehicle  $IM_{S/C}$ :

$$IM_{total}(no\ vehicule\ primary\ fragmentation) = IM_{S/C}$$

Note: Unreleased (or unborn) fragments do contribute to the impact mass because their mass is included in the aerodynamic mass of their parent objects.

### 7.11.3 Total number of processed objects

This corresponds to the number of objects defined in the DEBRISK graphical interface, without considering their quantity. This includes the satellite, meaning there is one object per line in the DEBRISK UI. This value is useful for deriving the average computation time required for a DEBRISK simulation.

### 7.11.4 Total impacting number of fragments

If the satellite does not fragment: that value is 1. If the satellite gets fragmented: the value is the sum of the fragments impacting the ground. For example, an element that falls to the ground with 10 unborn (NC) objects inside will count as a single object impacting the ground.

### 7.11.5 Total survivability

DEBRISK computes the global survivability parameter, which is an indicator of the overall ablation rate of the vehicle. It is defined for the N debris that are exclusively one the two following cases:

- The satellite itself is not included in these N debris because it fragments. The case where the satellite does not undergo ablation is specified below.
- The offspring of non-ablated or partially ablated objects are not considered (objects marked as "NC" – not calculated – in the output).

The formula is:

$$Global\_survivability\_parameter = \frac{\sum_{i=1}^N q_i * Alt_{final,i}}{\sum_{i=1}^N q_i * Alt_{frag,i}} - \frac{\sum_{i=1}^N q_i * Mass_{final,i}^{th}}{\sum_{i=1}^N q_i * Mass_{init,i}^{th}}$$

With :

- $Alt_{final,i}$  is the final altitude of the debris  $i$ ,
- $Alt_{frag,i}$  is the birth altitude of the debris  $i$ ,
- $Mass_{final,i}^{th}$  is the final thermal mass of the debris  $i$ ,
- $Mass_{init,i}^{th}$  is the initial thermal mass of the debris  $i$ ,

	CNES  DEBRISK		Ref.	DBK-MU-LOG-0268-THA	
			Date	13/11/2025	
			Version	2.23	Page: 88/120

- $q_i$  is the multiplicity of the debris  $i$ .

In the special event where the satellite does not fragment (the automatic fragmentation mode is activated), the final thermal mass is equal to the initial thermal mass, and the initial altitude is zero. Consequently, the global survivability parameter equals -1.

Note: The global survivability parameter has a minimum value of -1 when all components of the satellite re-enter intact (i.e., not ablated). It reaches a maximum value of +1 when all components disappear immediately upon release. This makes it the inverse of a risk criterion.

### 7.11.6 Total wall time

The real time required to complete the DEBRISK computation.

### 7.11.7 Total CPU time

The CPU time required to complete the DEBRISK computation.

### 7.11.8 Fragmentation altitude

In the case of manual fragmentation (user-imposed), this is the fragmentation altitude specified as an entry in DEBRISK and is not strictly considered a Quantity of Interest (QoI). However, in the case of automatic fragmentation, it becomes an output for sensitivity analysis. In all cases, it is an output.

## 7.12 Normal shutdown

To shut down the DEBRISK software, use the “Quit” function in the main menu, accessible in the top left-hand corner.

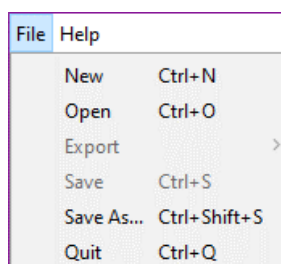



Figure 63 Closing the software.

If the results of any of the simulations defined have not been saved, a warning pop-up is displayed to the operator.

	CNES		Ref.	DBK-MU-LOG-0268-THA	
	DEBRISK		Date	13/11/2025	
			Version	2.23	Page:

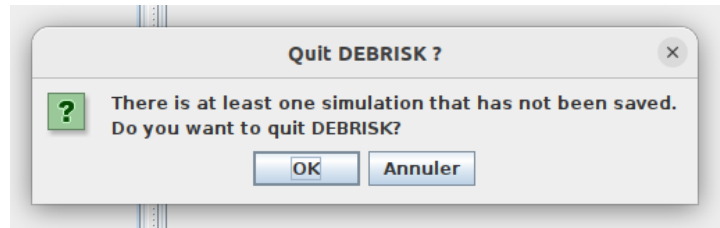


Figure 64 Simulation not saved warning pop-up

## 8 Error situation

Section 9.3 describes the possible error messages in DEBRISK according to their location or reason for being displayed, as well as the procedure to be applied in these cases.

### 8.1 Recovery procedures

Similarly, section 9.3 describes the possible error messages in DEBRISK according to their location or reason for being displayed, as well as the procedure to be applied in these cases.

### 8.2 Java Virtual Machine (JVM) memory management

The maximum memory size that the JVM allows DEBRISK will depend on several issues, mostly on the operating system (OS).

In particular, on Windows 32 bits, the JVM limits the maximum memory size for DEBRISK to about 300 Megabytes. When this limit is reached, the garbage collector is triggered in order to try to free some memory, and the DEBRISK application is slowed down.

It's somehow possible to handle the JVM in terms of memory allocation, via the following parameters:

-Xmx<size>: It allows defining the maximum memory size of the JVM.

-Xms<size>: It allows defining the memory size that will be allocated on JVM start.

The size is defined with a value and the units. For instance, to launch DEBRISK on a Windows 32 bits machine with a memory size of one Gygabyte, the command line would be:

```
java -Xmx1024m -Xms1024m -jar debrisk.jar
```

	<p>CNES</p> <p>DEBRISK</p>		Ref.	DBK-MU-LOG-0268-THA	
			Date	13/11/2025	
			Version	2.23	Page: 90/120

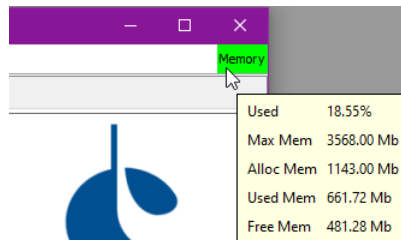
It's recommended to use the same value for the initially allocated memory (-Xms) and the maximum memory size (-Xmx). A minimum value of 1024m for both parameters is recommended when running on a Windows 32 bits architecture.

For further information on the management of memory by the JVM, please refer to the following link: <http://docs.oracle.com/cd/E19563-01/819-4438/gavou/index.html>

In order to monitor the current memory consumption, a dedicated area (called "Memory") has been included in the top for the main DEBRISK window. It is displayed in green when the consumed memory is below 75% of the available memory, in red if it is above 90% and orange otherwise.

	<p>CNES</p> <p>DEBRISK</p>		Ref.	DBK-MU-LOG-0268-THA	
			Date	13/11/2025	
			Version	2.23	Page: 91/120

When passing the mouse over this area, dedicated information is shown:



**Figure 65 Memory monitor**

Information included in this area includes:

- Used Memory (%): percentage defining the used memory with respect to the maximum available one
- Maximum Memory: it is the maximum quantity of memory to be dedicated to the current process
- Allocated Memory: it is the memory that has been allocated by the program in current run
- Used Memory: it is the real memory currently being used
- Free Memory: it is the current free memory (difference between the allocated and the used memory)

	CNES  DEBRISK		Ref.	DBK-MU-LOG-0268-THA	
			Date	13/11/2025	
			Version	2.23	Page: 92/120

## 9 Reference manual

### 9.1 Introduction

Keyboard shortcuts in the main window can be used to access the different DEBRISK menus/options:

- ALT + F: pulls down the “File” menu
- CTRL + N: execution of the “New” menu
- CTRL + O: execution of the “Open” menu
- CTRL + S: execution of the “Save” menu
- CTRL + Q: execution of the “Quit” menu
- ALT + H: pulls down the “Help” menu
- F1: execution of the “Help-> Show help” menu
- CTRL + A: execution of the “Help->About” menu
- CTRL + W: closing of the active simulation tab

The following commands can be used in the window panes or forms:

- TAB: used to move from one field to the next
- Enter: is used to validate the form
- Esc: is used to close the current window pane
- F1: is used to display Help.

### 9.2 Definitions and operation of the monitor

The station must be equipped with a monitor with minimum resolution of 1280x1024.

### 9.3 Plate ablation

	<p>CNES</p> <p>DEBRISK</p>		Ref.	DBK-MU-LOG-0268-THA	
			Date	13/11/2025	
			Version	2.23	Page: 93/120

The ablation of the plate will be realised modifying the length and width of the plate but maintaining its thickness.

## 9.4 *Error messages*

If the input parameters are not conforming to the use of the software, an error message is displayed. Input parameters are expected in the following cases:

- Entry of initial conditions
- Creation of objects
- Creation of a new material
- Reading of an input file

In addition, messages of the “operation” type can also be displayed.

### 9.4.1 **Error messages when entering the initial conditions**

When a field is not correct, the following message is displayed:

Error in one of the input fields: <errorMessage>


<errorMessage> can be:

- The initial date is not correct
- Fragmentation altitude should be between 70 km and 100km
- The eccentricity cannot be negative
- Inclination angle should be between 0° and 180°
- Impossible to create Orbit with these values

### 9.4.2 **Error messages when creating an object**

The creation of objects must be done according to certain rules (see chapter 7.5.1.3).

Failure to comply with these rules causes an error message in the input window as shown below:

	CNES  DEBRISK		Ref.	DBK-MU-LOG-0268-THA	
			Date	13/11/2025	
			Version	2.23	Page: 94/120

Name*:	Spacecraft
Total mass of vehicle with SP [kg]*:	10000.0
Object's quantity*:	1
Shape:	Cylinder
Specification:	hollow: outer radius [m],inner radius [m],length [m]
Material:	Aluminium DEBRISK
Outer radius [m]*:	2.0
Inner radius [m]*:	-3.0
Length [m]*:	1.0
Conduction Coefficient [W/K]:	0.0

Object warnings:

The inner radius cannot be negative  
 The outer length should be larger than twice the thickness

Apply Cancel Solar Panels Help  3D Active  Cut view

**Figure 66 Error message**

These messages are either generic (independent of the shape of the object):


- “Object name shall not contain ‘#’”
- “The volume cannot be negative”
- “The mass should be > 1e-10.”
- “Invalid values found! <VALUES>.”

This message means that the properties of the object are not physical. Here <VALUES> indicates the properties of the object so that the user can make the correction.

	CNES  DEBRISK		Ref.	DBK-MU-LOG-0268-THA	
			Date	13/11/2025	
			Version	2.23	Page: 95/120

Depending on the shape of the object:

- Sphere:
  - “The inner radius cannot be negative.”
  - "The outer radius cannot be negative."
  - "The inner radius cannot be larger than 100m."
  - "The outer radius cannot be larger than 100m."
  - "The outer radius cannot be smaller than inner radius"
  - "The mass cannot be negative"
  - "The thickness cannot be negative"
  - "Resulting inner radius (<VALUE>) cannot be negative"
  - "Resulting outer radius (%s) cannot be larger than 100m"
  - "The mass cannot be greater that the equivalent solid sphere (<VALUE> > <VALUE>).”

	<p>CNES</p> <p>DEBRISK</p>		Ref.	DBK-MU-LOG-0268-THA	
			Date	13/11/2025	
			Version	2.23	Page: 96/120

- Cylinder:
  - "The inner radius cannot be negative."
  - "The outer radius cannot be negative."
  - "The outer length cannot be negative."
  - "The inner radius cannot be larger than 100m."
  - "The outer radius cannot be larger than 100m."
  - "The outer length cannot be larger than 100m."
  - "The outer radius cannot be smaller than inner radius"
  - "The thickness cannot be negative"
  - "The mass cannot be negative"
  - "Resulting inner radius (<VALUE>) cannot be negative"
  - "Resulting thickness (<VALUE>) cannot be negative"
  - "The mass cannot be greater that the equivalent solid cylinder (<VALUE> > <VALUE>)."
  - "The outer length should be larger than twice the thickness"

	CNES  DEBRISK		Ref.	DBK-MU-LOG-0268-THA	
			Date	13/11/2025	
			Version	2.23	Page: 97/120

- Box:



- "The length should be larger than the width."
- "The width should be larger than the height."
- "The height should be larger than twice the thickness."
- "The width cannot be negative."
- "The mass cannot be negative"
- "The thickness cannot be negative"
- "The length cannot be negative."
- "The height cannot be negative."
- "The length cannot be larger than 100m."
- "The width cannot be larger than 100m."
- "The height cannot be larger than 100m."
- "The mass cannot be greater that the equivalent solid box (<VALUE> > <VALUE>)."

- Plate

- "The width cannot be negative."
- "The length cannot be negative."
- "The thickness cannot be negative"
- "The mass cannot be negative"
- "The width cannot be larger than 100m."
- "The length cannot be larger than 100m."
- "The length should be larger than the width."
- "The thickness cannot be larger than 10% of the width. Please use a box instead."

	CNES  DEBRISK		Ref.	DBK-MU-LOG-0268-THA	
			Date	13/11/2025	
			Version	2.23	Page: 98/120

- Complex
  - "The minor diameter cannot be negative"
  - "The major diameter cannot be negative"
  - "The height cannot be negative"
  - "The thickness (<VALUE> m) shall be less than 10.0% of the apothem (<VALUE> m)"
  - "The thickness cannot be larger than 100.0 mm"
  - "The mass (<VALUE> kg) cannot be negative";
  - "The height (<VALUE> m) cannot be larger than 100.0 m"
  - "The minor diameter cannot be larger than 100.0 m"
  - "The major diameter cannot be larger than 100.0 m"
  - "The volume (<VALUE> m3) shall be larger than 0 for complex shape"
  - "The angle (<VALUE> deg) shall be larger than 0"
  - "The angle (<VALUE> deg) cannot exceed 360.0 deg"
  - "The flatness (<VALUE>) shall be either 1 or 2 "
  - " The major diameter (<VALUE> m) cannot be smaller than the minor diameter (<VALUE> m)"
- Complex spherical
  - "The combination of the small diameter and thickness is such that the internal minor diameter is negative"
  - " $h > \sqrt{\text{large\_radius}^2 - \text{small\_radius}^2}$  (<VALUE> > <VALUE>) [m] "
- Complex conical
  - "The combination of the small diameter and thickness is such that the internal minor diameter is negative (<VALUE> m)"

	CNES  DEBRISK		Ref.	DBK-MU-LOG-0268-THA	
			Date	13/11/2025	
			Version	2.23	Page: 99/120

- Tube
  - "The outer radius cannot be negative"
  - "The inner radius cannot be negative"
  - "The outer length cannot be negative"
  - "The outer radius cannot be larger than 100.0 m"
  - "The inner radius cannot be larger than 100.0 m"
  - "The outer length cannot be larger than 100.0 m"
  - "The outer radius cannot be smaller than inner radius"

### 9.4.3 Error messages when creating a new material

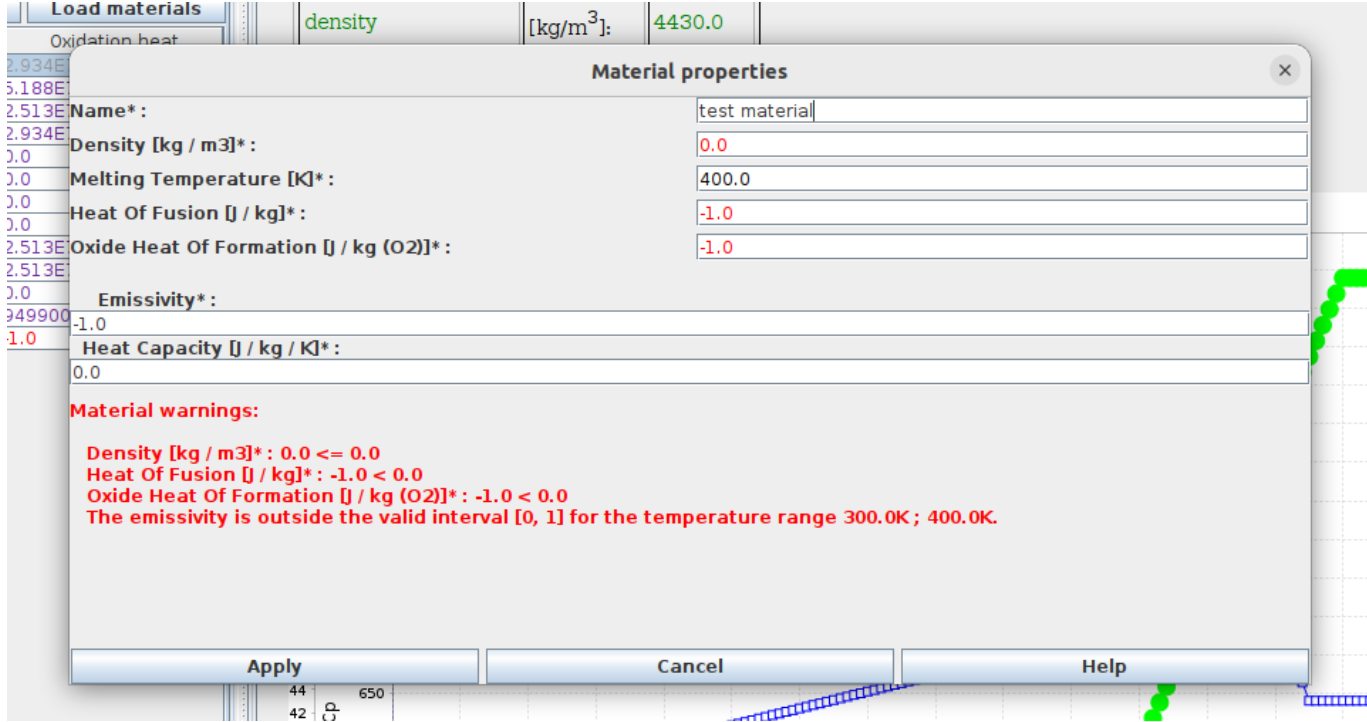


Figure 67 Entry of a user-defined material

If a mandatory field is not filled in, an error message is displayed:

“The following errors occurred:

<MSG>

You’ll have to correct the errors before you can continue.”

<MSG> can be:

- “A name should be specified”
- “This name already exists”
- “The density is not valid”
- “The melting temperature is not valid”
- “The heat of fusion is not valid”

	<p>CNES</p> <p>DEBRISK</p>		Ref.	DBK-MU-LOG-0268-THA	
			Date	13/11/2025	
			Version	2.23	Page: 101/120

- “The oxide heat of formation is not valid”
- “The emissivity is not valid”
- “The heat capacity is not valid”

If a negative emissivity or heat capacity is introduced by the user, the following error occurs:

“<MSG> Material Emissivity is not positive in all the temperature range.”

If a negative heat capacity is introduced by the user, the following error is obtained:

“<MSG> Material Heat Capacity is not positive in all temperature range.”

#### 9.4.4 Error messages when reading an input file

If the format of the input file is not the expected format, an error message is displayed.

“<MSG> Check the log file for more details”.

<MSG> depends on the exception type. The possible exceptions and the corresponding message are listed below:

- CVSFileException: “Error reading/writing CSV file: <ERROR> (<file\_path>)”
- InvalidDasFileException: “This is not a valid DAS file (<file\_path>). Operation aborted.”
- InvalidDebriskDirectoryException: “The installation directory does not contain the necessary files. Please check the installation files and restart. Debrisk will quit now.”
- InvalidUserMaterialFileException: “The user defined materials file is not valid (<file\_path>). Operation aborted.”
- InvalidXMLFileException: “This is not a valid Debrisk XML file (<file\_path>). Operation aborted.”
- KMLFileException: “Error reading/writing KML file: <ERROR> (<file\_path>)”
- OrekitConversionException: “Cartesian conversion error. Operation aborted.”
- OrekitNotInitializedException: “Orekit not initialised. Operation aborted.”
- TecplotFileException: “Error reading/writing Tecplot file: <ERROR> (<file\_path>)”
- XMLFileException: “Error reading/writing xml file: <ERROR> (<file\_path>)”
- ZipFileException: “Error reading/writing zip file: <ERROR> (<file\_path>)”

	CNES  DEBRISK		Ref.	DBK-MU-LOG-0268-THA	
			Date	13/11/2025	
			Version	2.23	Page: 102/120

### 9.4.5 Operation error messages

- If the simulation exceeds 1000000 seconds, the following message is displayed:  
“Simulation took more than the max duration (xxx s).”
- During an export, if the output file already exists but is not accessible (rights), the user is warned by the following message:  
“The file to write to already exists but it cannot be deleted. Please check the permissions on this file and try again.”
- When an attempt is made to import a simulation when the current tab already contains data, the following message is displayed, and the simulation is loaded in a new tab:  
“Current tab already contains data; data will be stored in new tab.”
- If the user tries to add an object at the root of the tree when a spacecraft already exists (there can only be one spacecraft), the following message is displayed:  
“You can’t add a spacecraft: please first select the spacecraft item in object list if you want to add children or edit the current spacecraft.”
- If a simulation loaded from a file contains unknown materials, the following message is displayed:  
“Cannot create material of type <MATERIAL\_TYPE>.  
Properties will be taken from titanium.”
- When loading a DAS file, the following message may be displayed if certain materials are not recognised:  
“DAS file contains n entries.  
<NB> unknown materials found.  
Please check your table for unknown materials,  
They currently have the same thermal properties as Titanium.”
- When a problem is detected during the propagation of an object, this object is shaded in the interface and the user is warned by the following message at the end of the simulation:  
“The computation has ended but n object(s) could not be computed correctly.  
These objects are indicated in grey.”  
Here, “n” indicates the number of objects in error.  
  
To find out the details of the errors, the user must do an XML export (“save” option) and look up the file generated. This contains, for each calculated object (“<object>” tag), a “results” tag containing the calculation results for this object. Inside, a “<stopReason>” tag gives a description of the error which caused the simulation of this object to stop.

Errors of the “abnormal” type may also occur:

	<p>CNES</p> <p>DEBRISK</p>		Ref.	DBK-MU-LOG-0268-THA	
			Date	13/11/2025	
			Version	2.23	Page: 103/120

- If the user presses F1 to display Help and the user's manual has not been found in the DEBRISK installation directory, the following message is displayed:

“The document DBK-MU-LOG-0268-THA.pdf could not be found. (Help unavailable)”

- If the files required for the operation of DEBRISK, and usually located in the directory containing the DEBRISK executable file, are not found, the following message is displayed:

“The installation files have not been found.

Those files should be in the directory where the debrisk.jar is installed.

In your case this is <installationDirectory>

For the current execution only, you'll be asked to select the directory where the installation files are located.”

Messages of the “internal” type may also be displayed: They start with “Internal error” and indicate a malfunction of the application (case not managed by the application).

Confirmation messages can also be displayed if the program has to delete or replace an existing file.

	CNES		Ref.	DBK-MU-LOG-0268-THA	
	DEBRISK		Date	13/11/2025	
			Version	2.23	Page: 104/120

## 9.5 3D View configuration

The 3D view configuration colours can be configured by the user through the *dirPath.properties* file that is located in the installation directory after loading or saving a configuration.





The 3D view is activated by default, if the program does not work correctly using the 3D view (graphic card problem, etc) the 3D view can be deactivated manually by editing the *dirPath.properties* manually and setting the value of the property *isUse3DActivated* to *false*.

The following values can be modified to configure the 3D view:


Key	Value	Range
<i>isUse3DActivated</i>	Selects if the 3D View is active	[true, false]
<i>view3D.backgroundRed</i>	Background red channel value	[0.0, 1.0]
<i>view3D.backgroundGreen</i>	Background green channel value	[0.0, 1.0]
<i>view3D.backgroundBlue</i>	Background blue channel value	[0.0, 1.0]
<i>view3D.outerSurfaceRed</i>	Shape's outer surface red channel	[0.0, 1.0]
<i>view3D.outerSurfaceGreen</i>	Shape's outer surface green channel	[0.0, 1.0]
<i>view3D.outerSurfaceBlue</i>	Shape's outer surface blue channel	[0.0, 1.0]
<i>view3D.outerSurfaceAlpha</i>	Shape's outer surface alpha channel	[0.0, 1.0]
<i>view3D.innerSurfaceRed</i>	Shape's inner surface red channel	[0.0, 1.0]
<i>view3D.innerSurfaceGreen</i>	Shape's inner surface green channel	[0.0, 1.0]
<i>view3D.innerSurfaceBlue</i>	Shape's inner surface blue channel	[0.0, 1.0]
<i>view3D.innerSurfaceAlpha</i>	Shape's inner surface alpha channel	[0.0, 1.0]
<i>view3D.borderSurfaceRed</i>	Shape's border surface red channel	[0.0, 1.0]
<i>view3D.borderSurfaceGreen</i>	Shape's border surface green channel	[0.0, 1.0]
<i>view3D.borderSurfaceBlue</i>	Shape's border surface blue channel	[0.0, 1.0]
<i>view3D.borderSurfaceAlpha</i>	Shape's border surface alpha channel	[0.0, 1.0]
<i>view3D.complexBorderSurfaceRed</i>	Complex shape's border surface red channel	[0.0, 1.0]
<i>view3D.complexBorderSurfaceGreen</i>	Complex shape's border surface green channel	[0.0, 1.0]
<i>view3D.complexBorderSurfaceBlue</i>	Complex shape's border surface blue channel	[0.0, 1.0]
<i>view3D.complexBorderSurfaceAlpha</i>	Complex shape's border surface alpha channel	[0.0, 1.0]

The other values in the *dirPath.properties* file are managed internally by *DEBRISK* and shall not be modified.

	<p>CNES</p> <p>DEBRISK</p>		Ref.	DBK-MU-LOG-0268-THA	
			Date	13/11/2025	
			Version	2.23	Page: 105/120

9.6

-  
-  
-

	CNES  DEBRISK		Ref.	DBK-MU-LOG-0268-THA	
			Date	13/11/2025	
			Version	2.23	Page: 106/120

## 10 Tutorial

### 10.1 Introduction

The purpose of this part is describing briefly the general operation of DEBRISK; it proposes a typical case of object creation and the creation of result files.

### 10.2 Starting up

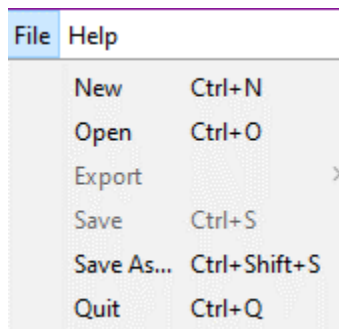


Figure 68 Menu

The following functions can be accessed from the *File* menu, in the top left-hand corner of the screen:

“New”: this creates a new tab in which you can create or open a new case to be studied.


“Open”: is used to open a previously saved study case.

“Export”: is used to export files to other software packages (Tecplot, Google Earth, CSV).



The *Tecplot*, *Google Earth* and *CSV* files will be encoded following the UTF-8 format. Hence, in order to be able to read it properly, you must use a text editor compatible with UTF-8 (such as notepad++, for instance).


If we want to import the file in Excel or any other program, you must indicate during this process that the file is encoded in UTF-8 format. The parameters contained in these files are detailed below:

	CNES  DEBRISK		Ref.	DBK-MU-LOG-0268-THA	
			Date	13/11/2025	
			Version	2.23	Page: 107/120

- CSV file

The CSV file contains a header with the name, date of creation, version of DEBRISK and mode (SCI or LOS). This header is then followed by the data:

Parameter	Units
Parent id	--
Id	--
Name	--
Quantity	--
Shape	--
Material	--
Initial altitude(m)	m
Initial mass(kg)	kg
Rout/Height(m)	m
Rin/Width/Rsmall(m)	m
Length/Rlarge(m)	m
Thickness(m)	m
Angle(deg)	deg
Cb_intial(kg/m2)	kg/m2
Stop reason	--
Demise altitude(m)	m
Impact mass(kg)	kg
Final Rout/Height(m)	m
Final Rin/Width/Rsmall(m)	m
Final Length/Rlarge(m)	m
Final Thickness(m)	m
Final angle(deg)	deg
Cb_onGround(kg/m2)	kg/m2
Impact energy(J)	J
Cross section area(m2)	m2
Total casualty area(m2)	m2

	CNES  DEBRISK		Ref.	DBK-MU-LOG-0268-THA	
			Date	13/11/2025	
			Version	2.23	Page: 108/120

Parameter	Units
Weighted casualty area(m2)	m2
Initial CCond(W/K)	W/K
Final CCond(W/K)	W/K
End temperature(K)	K
Max temperature(K)	K

- Tecplot file

The first lines of the Tecplot contain the name, date of creation, version of DEBRISK and mode (SCI or LOS). Then, the Tecplot files contains the following data:

Parameter	Units
time(s)	s
altitude(m)	m
longitude(deg)	deg
latitude(deg)	deg
azimuth(deg)	deg
velocity(m/s)	m/s
velocityInertial(m/s)	m/s
acceleration(m/s2)	m/s2
flowRate(kg/s)	kg/s
downRange(km)	km
localDownRange(km)	km
downRangeShortest(km)	km
FPA(deg)	deg
extTemperature(K)	K
extDensity(kg/m3)	kg/m3
extPressure(Pa)	Pa
Mach	--

	CNES		Ref.	DBK-MU-LOG-0268-THA		
	DEBRISK		Date	13/11/2025		
			Version	2.23	Page: 109/120	

Parameter	Units
Knudsen	--
aerodynamicMass(kg)	kg
thermalMass(kg)	kg
kineticEnergy(J)	J
referenceAeroArea(m2)	m2
referenceThermalArea(m2)	m2
radiationArea(m2)	m2
outerArea(m2)	m2
wallTemperature(K)	K
Cd	--
dragForce(N)	M
ballisticCoefficient(kg/m2)	kg/m2
QconvColdWall(W/m2)	W/m2
Qconv(W/m2)	W/m2
Qoxidation(W/m2)	W/m2
QradGain(W/m2)	W/m2
QradLoss(W/m2)	W/m2
Qcond(W)	W
Qnet(W/m2)	W/m2

“Save”: is used to save the case being studied by including the list of objects and the initial conditions.

“Save As”: is used to save the case being studied under another name.

“Quit”: is used to close the software.

	<p>CNES</p> <p>DEBRISK</p>		Ref.	DBK-MU-LOG-0268-THA	
			Date	13/11/2025	
			Version	2.23	Page: 110/120

Entry conditions:

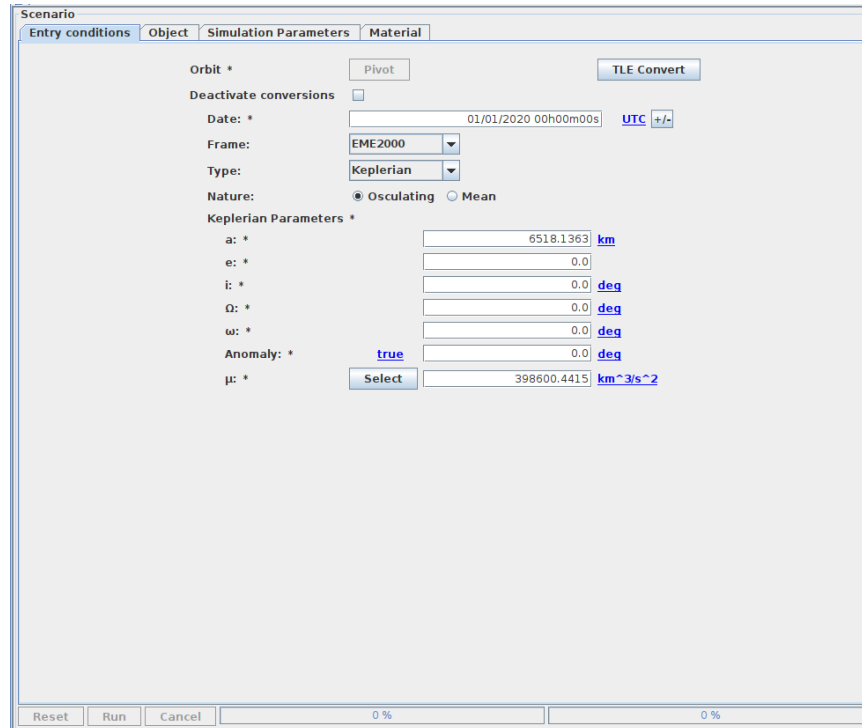



Figure 69 Entry conditions

	<p>CNES</p> <p>DEBRISK</p>		Ref.	DBK-MU-LOG-0268-THA	
			Date	13/11/2025	
			Version	2.23	Page: 111/120

## 10.2.1 Scenario area

You will find various tabs in this area. The first one, named “Entry conditions”, must be filled in with the general parameters of the entry point corresponding to the kinematic conditions of the spacecraft to be studied. The parameters to be entered are the parameters of the Keplerian orbit of the spacecraft object.

### 10.2.1.1 Object tab

The object tab allows you to add new objects using the *Add* button, to edit some objects already created using the *Edit* button, to duplicate objects using the *Duplicate* button or to delete others using the *Delete* button.

When clicking on “Duplicate”, the whole group of children, grandchildren... of the selected object will also be duplicated.

In the left part, you can see a tree representing the overall structure of the case you are about to simulate. The indentation of the elements in this tree shows the parent-child links existing between the different objects.

To add an object, select a parent object in the tree or the table and click on the *Add* button. A new window is displayed.

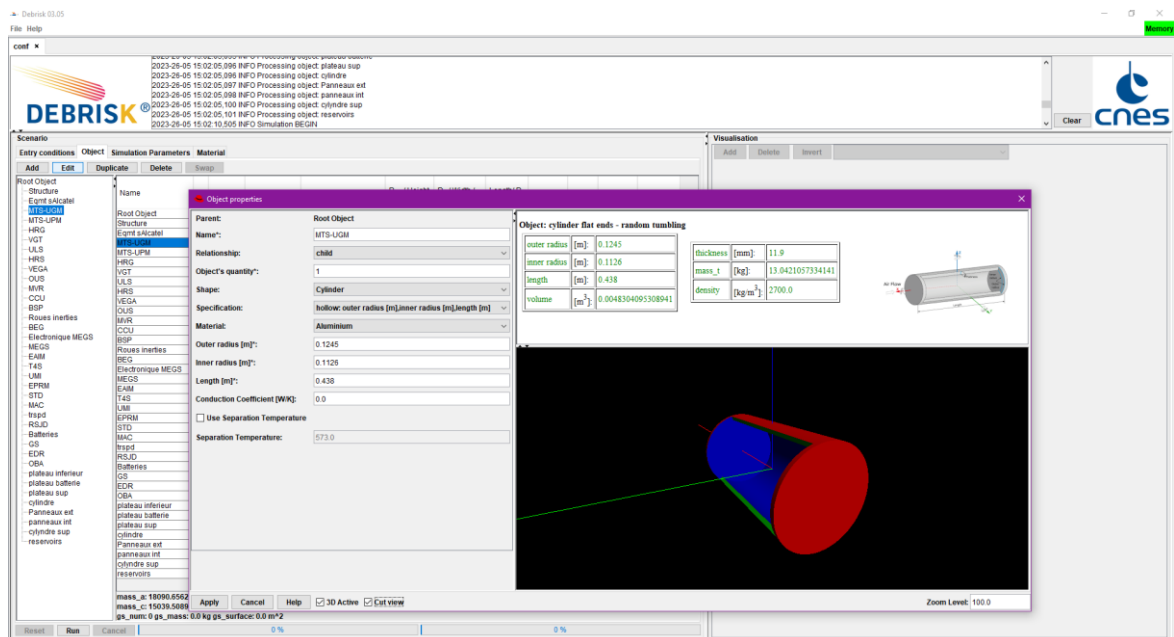


Figure 70 Creating an object.

	CNES  DEBRISK		Ref.	DBK-MU-LOG-0268-THA	
			Date	13/11/2025	
			Version	2.23	Page: 112/120

In this window, you are asked to enter the following elements:

- object name
- Relationship. This parameter allows to define if the new object is a standard “child” or a “component” of the parent object.
- Quantity of fragments. This parameter is used when the operator wants to define several fragments with the exact same characteristics. Even if  $Q > 1$ , a single simulation will be run for the fragment. This value will only be used to compute the aerodynamic mass of an object having children with  $Q = 1$  and for the casualty area (which will be computed as the casualty area of the simulated fragment multiplied by  $Q$ ).
- selection of the object shape
- selection of the mode for entry of the dimensions of the object according to the data at your disposal. All the other data will be calculated by DEBRISK so that they correspond to the data provided by the user.
- The material of the object to be selected in the list.
- Dimensions to be complemented according to the mode selected beforehand.
- Conduction coefficient.

Please note that the first object in the list is always a spacecraft, while the others are always fragments.

Solar panels can be added on the spacecraft object, modelled only by a box, a cylinder or a sphere, using the “solar panels” button, which is only displayed on the window for this object.

	CNES  DEBRISK		Ref.	DBK-MU-LOG-0268-THA	
			Date	13/11/2025	
			Version	2.23	Page: 113/120

### 10.2.1.2 Materials tab

In the materials tab, you will find the properties of the various materials used in the simulation. This includes the following parameters for each material:

- density in  $\text{kg/m}^3$
- heat of fusion in J/kg
- melting temperature in K
- oxidation heat in J/kg ( $\text{O}_2$ )

### 10.2.1.3 Viewing area

The viewing area is in the right part of the interface. It is used to analyse the evolutions of the various parameters during the simulation. The results are presented in five types of predefined graphs:

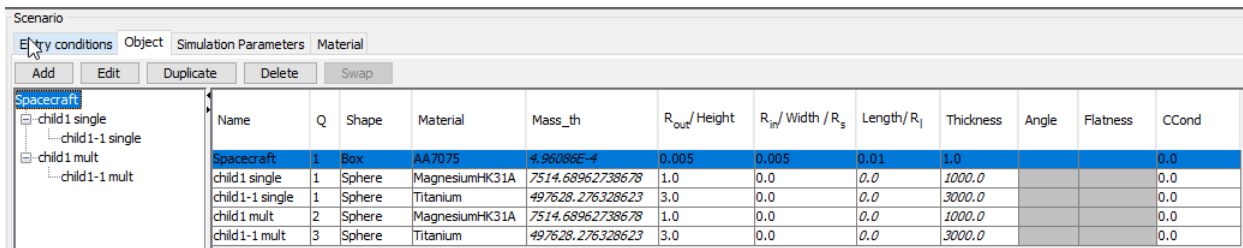
- altitude vs. time
- thermal mass vs. time
- thermal mass vs. altitude
- altitude vs. downrange
- temperature vs. time

In the table on the left, the columns have been modified to present a summary of the state at the end of the simulation for each object. We then find:

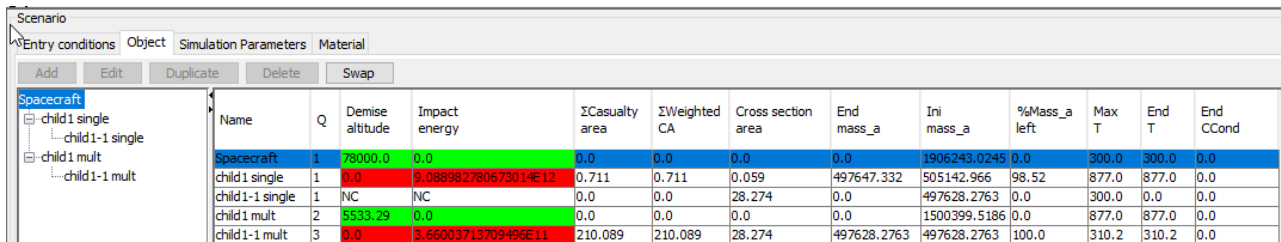
- the quantity of fragments
- the object destruction altitude: the cell is coloured in red if the object is not destroyed, and in green if it does not reach the ground. In case of error during the calculation, this cell is shaded (see §9.3).
- the energy on impact: the cell is coloured in red if the energy on impact is higher than 14J, in yellow if it is lower or equal, or in green if the object does not reach the ground. In case of error during the calculation, this cell is shaded (see §9.3).

- the casualty area in the case of an object which reaches the ground (sum of all the fragments if the quantity is > 1).
- The initial aerodynamic mass
- the final aerodynamic mass
- the percentage of aerodynamic mass left
- maximum surface used for the calculation of the casualty area
- the maximum temperature
- the final temperature

The user can switch between the views of the object panel (before/after execution) by clicking on the “Swap” button.





Name	Q	Shape	Material	Mass_th	R <sub>out</sub> /Height	R <sub>in</sub> /Width / R <sub>s</sub>	Length/R <sub>1</sub>	Thickness	Angle	Flatness	CCond
Spacecraft	1	Box	AA7075	4.96086E-4	0.005	0.005	0.01	1.0			0.0
child1 single	1	Sphere	MagnesiumHK31A	7514.68962738678	1.0	0.0	0.0	1000.0			0.0
child1-1 single	1	Sphere	Titanium	497628.276328623	3.0	0.0	0.0	3000.0			0.0
child1 mult	2	Sphere	MagnesiumHK31A	7514.68962738678	1.0	0.0	0.0	1000.0			0.0
child1-1 mult	3	Sphere	Titanium	497628.276328623	3.0	0.0	0.0	3000.0			0.0



Name	Q	Demise altitude	Impact energy	ECasualty area	EWeighted CA	Cross section area	End mass_a	Ini mass_a	%Mass_a left	Max T	End T	End CCond
Spacecraft	1	78000.0	0.0	0.0	0.0	0.0	0.0	1906243.0245	0.0	300.0	300.0	0.0
child1 single	1	0.0	9.0389982780673014E12	0.711	0.711	0.059	497647.332	505142.966	98.52	877.0	877.0	0.0
child1-1 single	1	NC	NC	0.0	0.0	28.274	0.0	497628.2763	0.0	300.0	0.0	0.0
child1 mult	2	5533.29	0.0	0.0	0.0	0.0	0.0	1500399.5186	0.0	877.0	877.0	0.0
child1-1 mult	3	0.0	3.66003713709496E11	210.089	210.089	28.274	497628.2763	497628.2763	100.0	310.2	310.2	0.0

Figure 71 Swap objects table view

	CNES		Ref.	DBK-MU-LOG-0268-THA		
	DEBRISK		Date	13/11/2025		
			Version	2.23	Page: 115/120	

Below the objects table we will find an entry where the total casualty area (corresponding to the addition of the casualty area of all the fragments) will be displayed, the value will only be displayed when an execution has been done and removed when the simulation is reset:

Reservoirs	1	22155.64	0.0	0.0
Total Casualty Area: 54.224 m2 Total Weighted Casualty Area: 48.547 m2				

Figure 72: Total casualty area value after an execution.

### 10.3 Using the software for a typical task

#### 10.3.1 Creation of a simulation and result files

From the *File* menu, in the top left-hand corner of the screen, click on the “New” tab: this creates a new tab in which you can create or open a new case to be studied.

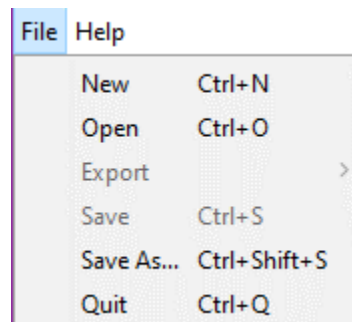




Figure 73 Menu

You will find various tabs in this area. The first one, named “Entry conditions”, must be filled in with the general parameters of the entry point corresponding to the kinematic conditions of the spacecraft to be studied. The parameters to be entered are the parameters of the Keplerian orbit of the spacecraft object.

	<p>CNES</p> <p>DEBRISK</p>		Ref.	DBK-MU-LOG-0268-THA	
			Date	13/11/2025	
			Version	2.23	Page: 116/120

Scenario

Entry conditions | Object | Simulation Parameters | Material

Orbit

Deactivate conversions

Date:

Frame:

Type:

Nature:  Osculating  Mean

Keplerian Parameters

a:  km

e:

i:  deg

Ω:  deg

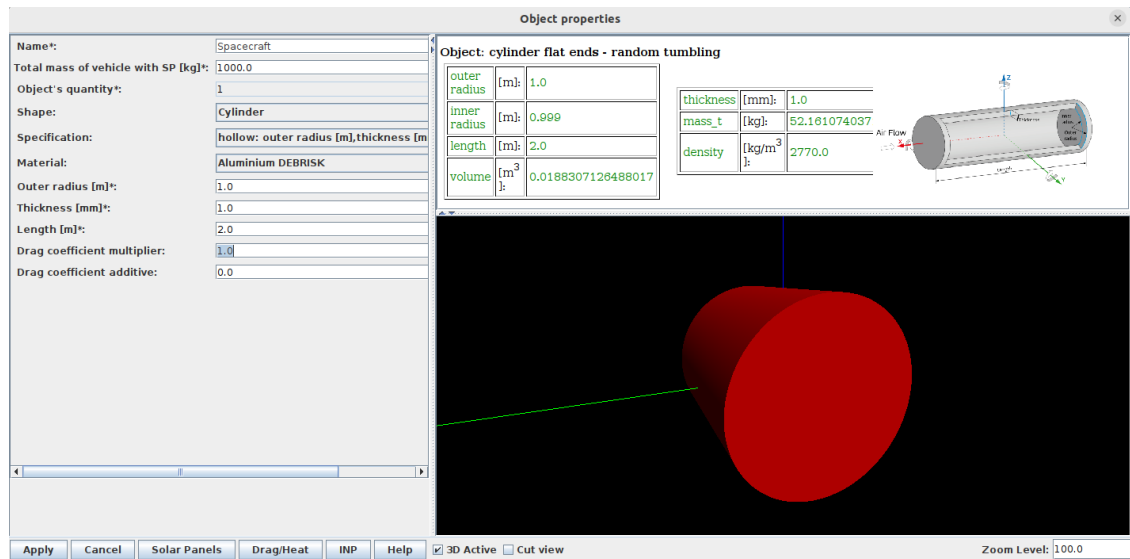
ω:  deg

Anomaly:   deg

μ:   km<sup>3</sup>/s<sup>2</sup>

Figure 74 Entry conditions

Click on the *object* tab, and then on the *Add* button; a new window is displayed:



**Figure 75** Creating a spacecraft.

- Enter the outer radius, for example 1m.
- Enter the thickness of the cylinder, for example 1mm
- Enter the length, for example 2m
- Enter the aerodynamic mass, for example 1000kg

Press “apply”, and then again on the *object* tab, and on the *Add* button to create a child object.

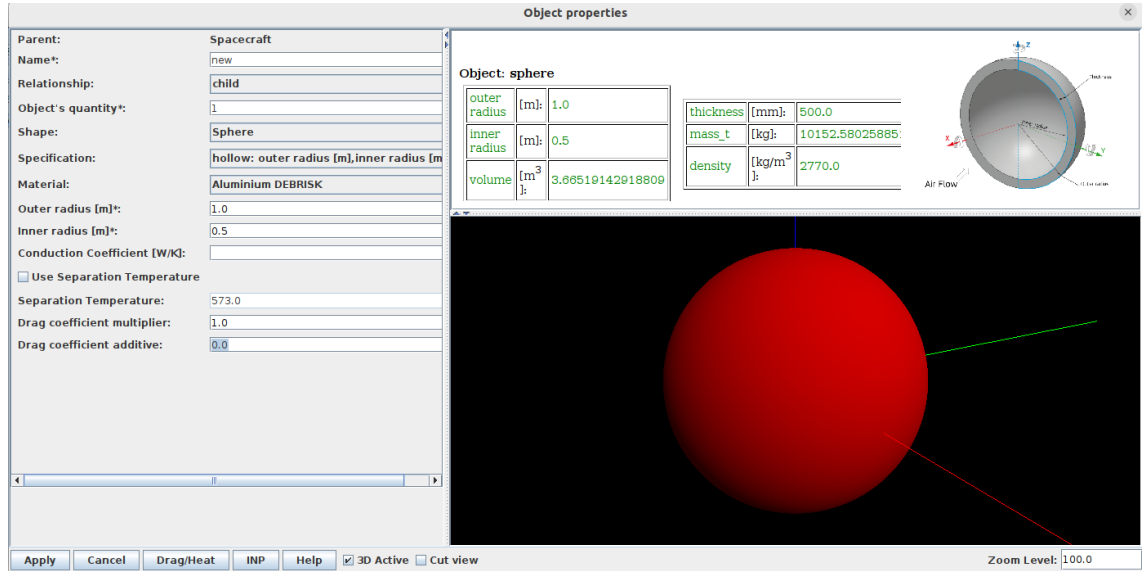


Figure 76 Creating a child object.

- Enter the outer radius, for example 1m.
- Enter the inner radius, for example 0.5m.

	<p>CNES</p> <p>DEBRISK</p>		Ref.	DBK-MU-LOG-0268-THA	
			Date	13/11/2025	
			Version	2.23	Page: 119/120

Then press “apply”

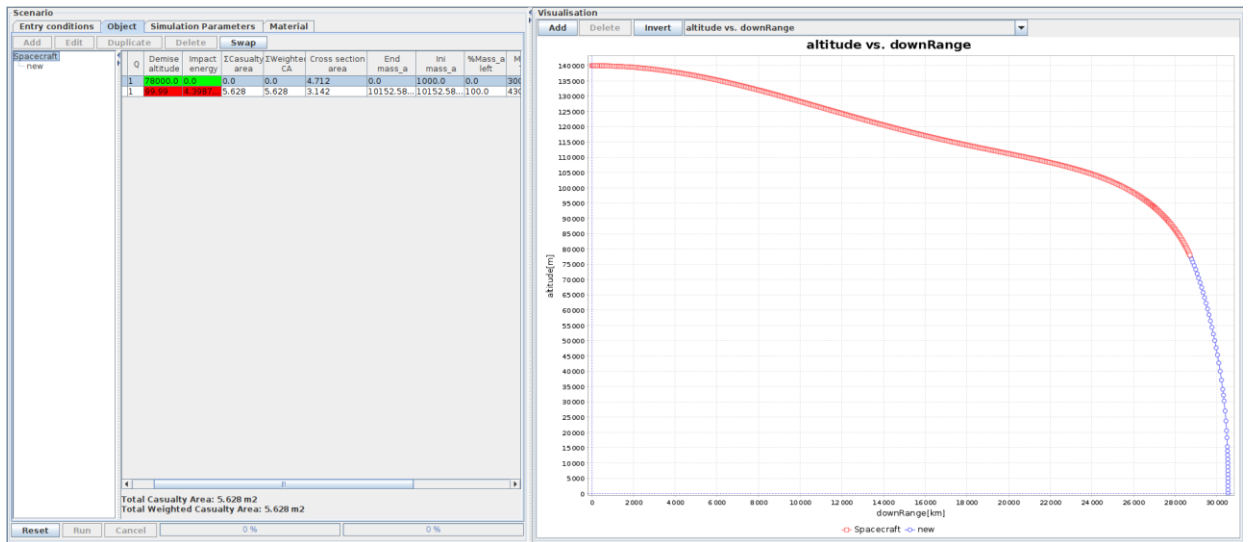


Figure 77 Results and viewing area.

Press “Run” to launch the simulation; you will see a graph displayed in the right part of the screen.

To save the simulation, different formats are available (Flat XML, Tecplot, Kml, CSV). To create one of these files, click on the File menu in the top left hand corner of the screen, click on the “Export” tab and select the desired format. It is possible to save all files at once by clicking on the “Zip” tab.

Name the file, then using the drop-down menu, choose the folder where you want to save the file. Note that the folder proposed by default is the last one used in DEBRISK.

Press “Save” to save the file in the folder you have chosen.

During the export of the file, the following pop-up will be displayed (a similar pop-up window is shown whatever the exported file is):

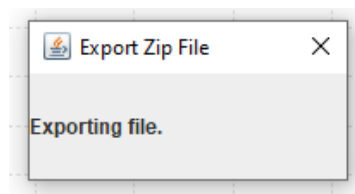




Figure 78 Export file pop-up

	CNES		Ref.	DBK-MU-LOG-0268-THA		
	DEBRISK		Date	13/11/2025		
			Version	2.23	Page: 120/120	



The flatXML, KML and XML file will be encoded following the UTF-8 format. Hence, in order to be able to read it properly, you must use a text editor compatible with UTF-8 (such as notepad++, for instance).

If we want to import the file in Excel, you must indicate during this process that the file is encoded in UTF-8 format.

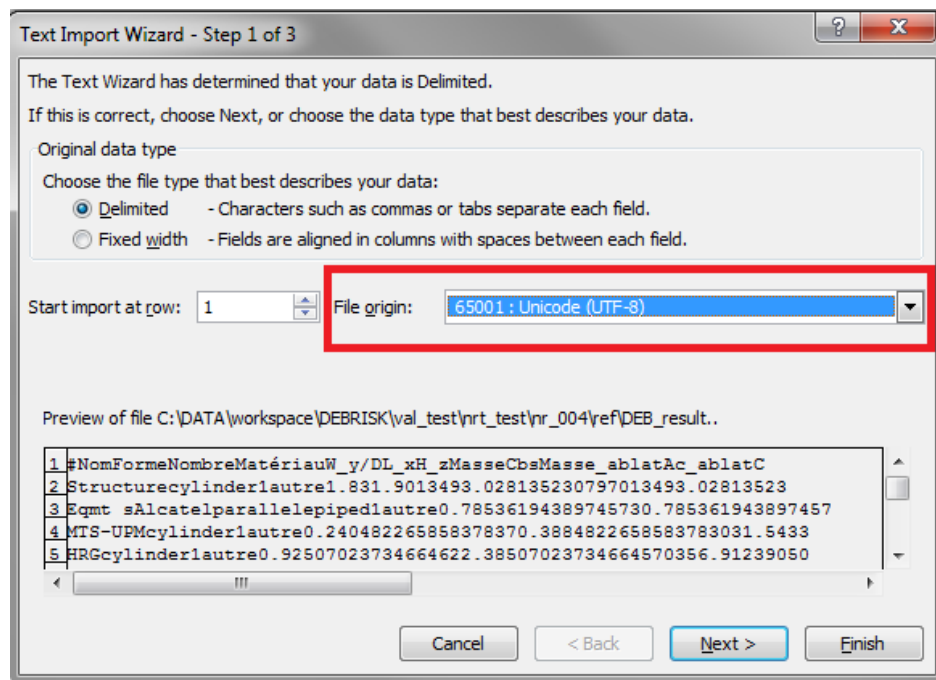


Figure 79 Importing a file encoded following the UTF-8 format in Excel